

FOR-X

www.for-x.com.tr

Owner's Manual

X-9200

INDASH MULTIMEDIA



CE

CONTENTS:

WARNINGS&PRECAUTIONS	01
PRODUCT FEATURES	01
INSTALLATION	02
Installation Procedures	02
Installation Opening	02
TO Install The Car Radio	02
ACCESSORY LIST	03
DIMENSION(UNIT:MM)	03
WIRING DIAGRAM	04
BASIC FUNCTIONS OF PANEL KEYS	05
REMOTE OPERATION	06
FUNCTIONAL APPLICATION	07
Main interface	07
Radio	08
USB/TF card	09
Music playback	09
Video playback	09
Telephone directory	10
Bluetooth connection	10
Call record	10
Bluetooth music	10
Call up	10
Steering wheel	11
Mobile Internet	11
TECHNICAL PARAMETERS	12
COMMON TROUBLE SHOOTING GUIDELINES.....	13

WARNINGS & PRECAUTIONS:

To avoid risk of serious injury or possible violation of laws, please read the following thoroughly before installation or connecting.

- This product is designed specifically for use with 12 volt, negative ground electrical systems only.
- Having the wiring and installation done by expert.
Be sure to disconnect the cable from the negative battery terminal while installation.
- This apparatus shall not be exposed to dripping or splashing, and no object filled with liquids shall be placed on the apparatus.
- Fuses shall be replaced only with the correct type and fuse value, and only when the apparatus is powered off.
- To prevent a short circuit, never put or leave any metallic objects (such as coins or metallic tools) inside the unit.
- Never set the volume of this product so high that you cannot hear outside traffic and emergency vehicles.

PRODUCT FEATURES:

1-DIN Car Indash Multimedia Player

Capacitive Touch Screen

USB playback

Bluetooth 5.0

Bluetooth music playback

Remote control operation

CVBS reverse video input

2.1A fast charging

iOS and Android phone connectivity

4x60W maximum power output

Preset 16 EQ, 4 sound effects, 1 customized Setting

Support Video AVI, MKV, MPG, ASF, FLV, TS

Support Audio MP3, WMA, AAC, WAVE, FLAC, APE

INSTALLATION

Installation Procedures

First complete the electrical connections and then check for correctness.

Installation Opening

This unit can be installed in any dashboard having an opening as shown below:



TO Install The Car Radio

Be sure you test all connections first, and then follow these steps to install this unit.



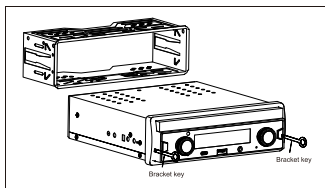

1. Make sure the ignition is turned off, and then disconnect the cable from the vehicle battery's negative (-) terminal.
2. Disconnect the wire harness and the antenna.
3. Remove the detachable panel and decorative enclosure frame and place on one side.
4. Insert the two brackets into the left and right sides of the chassis, as shown in the following figure, and separate the chassis from the sleeve.



5. Insert the installation sleeve into the center console to be installed, and bend the clip using a screwdriver. Make sure the locking rod is flush with the mounting sleeve and does not protrude.
6. Connect cables as shown in the wiring diagram.
7. Insert the car radio into the mounting sleeve.
8. Install decorative enclosure frame.

ACCESSORY LIST:

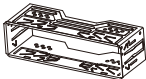
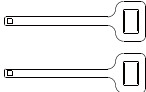
Please check the following accessories after opening the package:

<p>20P Cable</p> 	<p>Remote x1</p> 	<p>Frame x1</p>  <p>Install on the host</p>
<p>Half Sleeve x1</p>  <p>Install on the host</p>	<p>Disassemble Keys x2</p> 	<p>User Manual/Warranty Card/ Service Manual</p> 



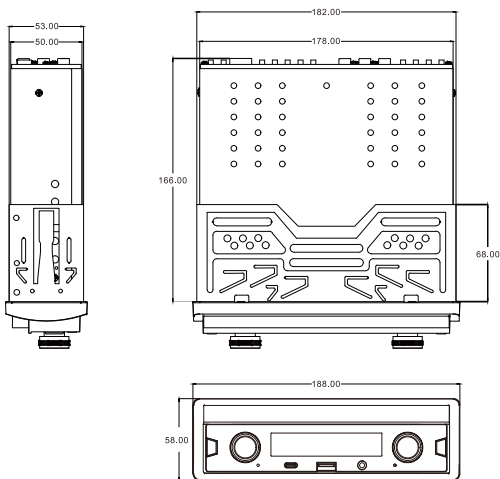

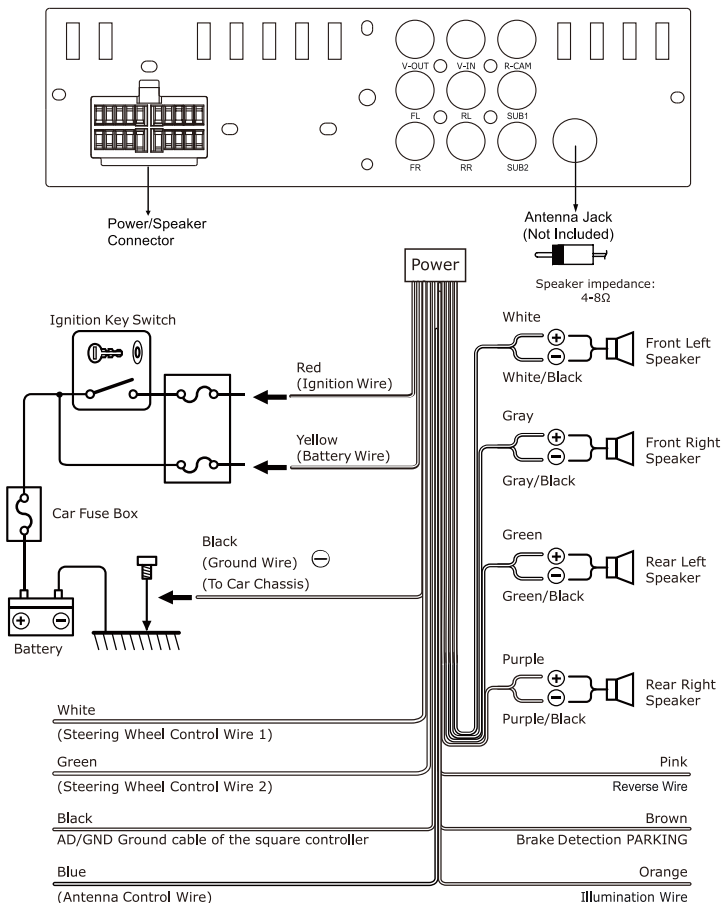

DIMENSION(UNIT:MM):



WIRING DIAGRAM:



PANEL FUNCTION DESCRIPTION:

FUNCTION INTRODUCTION	
USB	USB Port
MIC	Hands-free Microphone
SRC	Tap to switch modes
AUX	Auxiliary Input Jack
RST	Reset
	Type-c 2.1A Fast Charge
DIM	Click to switch between daytime mode/nighttime mode/sleep mode
	Click to enter the radio page and switch between FM1, FM2, Fm3
	Click to preview the radio channel, long press to automatically search and save the channel
	Click to raise the screen
	Click to drop the screen
	Short press to mute or unmute, long press to turn off the screen and retract it (in normal operation), short press to light up the display screen and extend it (in off state), turn the knob to adjust the volume
	Short press to pause or unpause, turn the knob to switch to the previous or next Music/Video/Radio

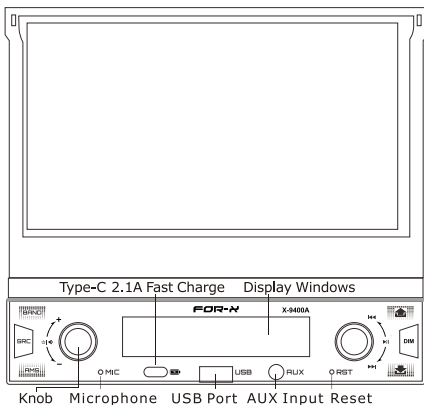

REMOTE OPERATION:

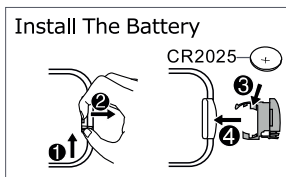
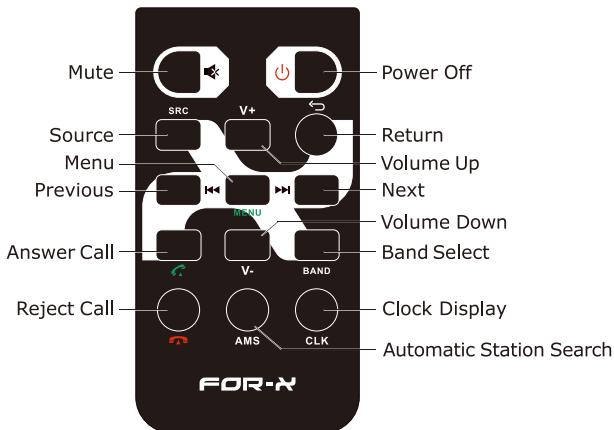





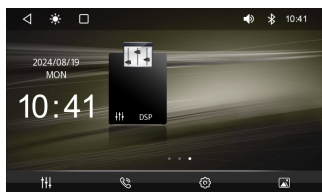
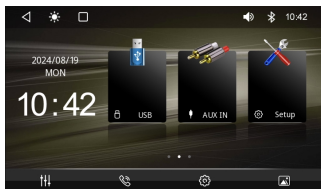
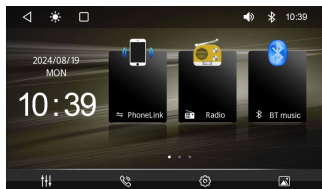









MAIN INTERFACE

On the home screen, swipe left to browse other apps





The functions are as follows:

-  : Click to return to the previous interface
-  : Click to switch between daytime mode/nighttime mode/sleep mode
-  : Click to return to the homepage
-  : Click to enter the mobile phone connection interface
-  : Click to enter the radio interface
-  : Click to enter the Bluetooth music interface
-  : Click to enter USB folder
-  : Click to enter the AUX IN interface
-  : Click to enter the setting interface
-  : Click to open the DSP setting interface
-  : Click to enter the EQ setting interface
-  : Click to enter the Bluetooth interface
-  : Click to enter the setting interface
-  : Click to switch wallpaper

RADIO

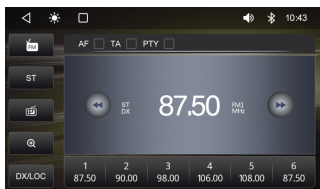
Touch the radio in the main menu to enter the radio interface.



 : Touch the icon to switch FM1/FM2/FM3.

 : Touch can trun on/off ST function.

 : Touch to open the keyboard for precise frequency input.

 : Touch the icon to search for frequency bands and automatically save the searched frequency bands

 : Touch can trun on/off LOC function.

AUX INPUT

Plug in video or audio input into the corresponding jack, then press the AUX icon to enter the Input interface.

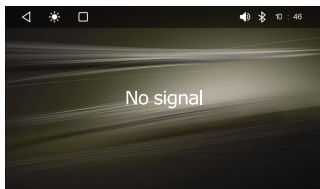

USB

Click on the USB icon on the main interface to enter the USB interface

USB Directory

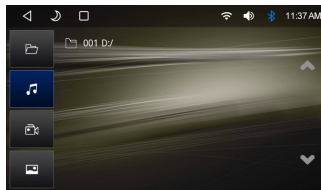

USB Music Playback

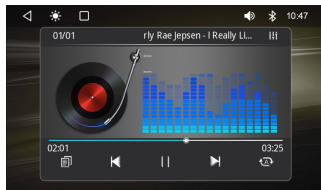

 In the USB Player screen, click to return to the USB directory

 File list

 Music list

 Video list

 Picture list

 Previous song

 Play/pause

 Next song

 Playlist

 EQ setting

 Random play/single loop/list loop

USB Directory

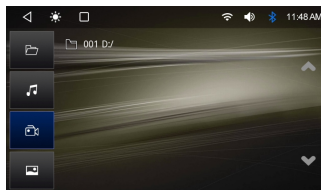

USB Video Playback

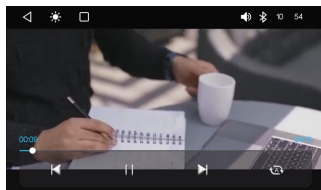

 In the USB Player screen, click to return to the USB directory

 File list

 Music list

 Video list

 Picture list

 Previous video

 Play/pause

 Next video

 Random play/single loop/list loop

BLUETOOTH

Click on the Bluetooth icon on the main interface to enter the Bluetooth interface

Call up

In this interface, calls can be dialed or answered locally

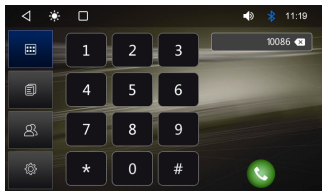

Call record

This interface allows you to view call records



Telephone directory

You can view saved phone numbers on this screen

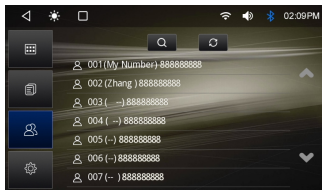

Bluetooth connection

Touch the icon and enter the Bluetooth connection interface

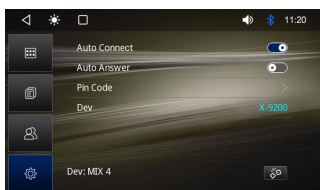

Bluetooth music

Play music from your Bluetooth connected device from this interface.



STEERING WHEEL

Enter the setting interface, select the steering wheel to learn,
Update SWC settings in this interface.

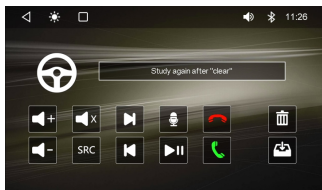

Click  Start Settings;.

Click on the function icon corresponding to this interface, and the icon will flicker.
Press the button on the SWC panel for a long time.

When the corresponding function icon stops flickering, loosen your finger.

Indicates that the setup was successful;

Click on the  icon to save, you can use the corresponding button on the SWC panel.

PHONE LINK

Click on the PhoneLink icon on the main interface to enter the PhoneLink interface

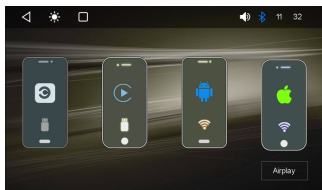

Select iOS/Android based on your phone type. After confirming the phone type, you can choose wired/wireless connection and follow the prompts to complete the connection

TECHNICAL PARAMETERS

Routine

Voltage: 14.4V (10.5-16V)

Working temperature: -10°C – +60°C

Storage temperature: -20°C – +70 °C

TFT Display Options

Display size: 7

Display resolution: 1024x600 IPS

Contrast degree": 500

Radio Options

FM Frequency Modulation

FM Range: 87.5-108.0MHZ

Supporting Video Format

AVI, MKV, MPG, ASF, FLV, TS

Audio format support

MP3, WMA, AAC, WAVE, FLAC,
APE

USB interface options

USB: Read

Charging

5V = 2.1A

Video options

External Video Input System:

NTSC/PAL/SECAM

External Video Input: 1VP-P/75Ω

Audio options

Maximum power: 4x60W

Front output(V): 2V/10KΩ

Pre-output impedance: <600Ω

Speaker impedance: 4-8Ω

Bluetooth options

Communication system: BT5.0 +EDR

Output: Bluetooth Standard Power

Level 2 Maximum communication

Range: About 5 meters.

Band: 2.4G

COMMON TROUBLESHOOTING GUIDELINES

Fault	Reason	Solution
Unable to boot	Power supply fuse burned out	Replacement of the same type of fuse
	Other factors cause microprocessors to work abnormally	Reboot by pressing the reset hole on the panel with the pointed object point
When the ignition switch is turned off, all the information of setting is lost.	Replacement of batteries or fuses	Reset the information and keep it
The radio is ineffective	Weak radio signal	Re-search by moving the car to another location
	Failure to connect radio antennas leads to weak signals	Connect the antenna and retrieve the station
No image	Other factors cause microprocessors to work abnormally	Reboot by pressing the reset hole on the panel with the point of the pointed object
Silent output	Small voice	Increase the volume required
	Output line incorrectly connected	Check Output Line Connection