

USER'S MANUAL
FOR-X

X-8290A

CAR RADIO AND MUSIC PLAYER
UNIVERSAL ANDROID



Instructions for use

Thank you for purchasing this product, please read this manual carefully before use to ensure that you can use the machine correctly. After reading the instructions, please keep it for future inspection.

Caveat

To prevent damage to the machine and to use the system safely, please

- To prevent short circuits, do not omit metal objects (coins or other metal) inside the machine.
- Do not install the unit in a way that hinders the driver's sight or affects the driver's operation. When you drive, please do not pay attention. In the system, do not watch the screen for a long time.
- The machine consists of high-precision components, should avoid a strong impact, not to unauthorized removal of the cover or adjust the parts, for maintenance, please go to a nearby professional service center consultation.

Before use

- When you purchase optional accessories or make related system settings, please check with the dealer whether they match the machine.
- You can select your favorite language display in the language setup menu. For more information, see Language Settings (page 4 of the manual)



Protect the display

- Protect the display from damage, do not use a ballpoint pen or sharp tool to touch the display.
- When the machine panel or display screen is dirty, wipe with a soft cloth and a mild
- You can not use hard cloth or alcohol and other corrosive thinner wipe the display or panel, so as to avoid the display or panel damage, blurred, the screen disappeared and so on.
- Please follow the instructions to use this machine, the damage caused by illegal operation is not covered by the warranty.

note

The machine display screen you see may be inconsistent with the picture of the manual, which is due to the unannounced software upgrade and update, does not affect the normal use.
Some function (DVD, color LED, TV, etc.) is optional. The device which you purchase may not includes all the functions that this manual listed.

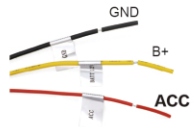
Troubleshooting

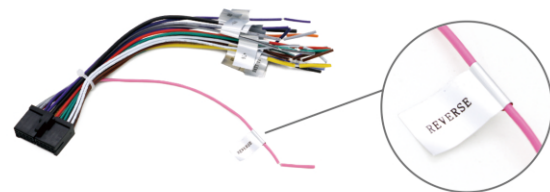
malfunction	solution
<p>Cannot power up</p> 	<p>Check the connection of AAC, B+, Ground.</p> <ol style="list-style-type: none"> 1. Connect AAC with ignition line. 2. Connect B+ to the positive pole of the battery. 3. Connect Ground to Ground.
<p>Can not read discs</p>	<p>Remove the screws</p>  <p>Note: Remove the screws before use</p>
<p>No image when reversing</p>	<p>Connect the car DVD's reversing line with the car's reversing line, to ensure the reverse camera workable.</p> 
<p>Navigation does not work</p>	<ol style="list-style-type: none"> 1. If map goes wrong, uninstall then re-install the map. 2. If map data destroyed, uninstall then re-install the map. 3. If GPS cannot search any signal, please check if the GPS antenna is well connected. If well connected, make sure the antenna is exposed to the air. If still not working, please replace a new antenna.
<p>The key light does not light</p>	<ol style="list-style-type: none"> 1. Check the headlight line connection. 2. Enable the button light on Setup.

Contents

Before Use

Warning

Basic Operations 01

Functions of the Buttons On the Front Panel 01

Turning on the Unit 01

Operation on the Home Screen

> home screen 02

> source, network 02

> move and delete icons..... 03

> change the skin 03

Clock and Date Setup 03

Start Logo Setup 03

Language Setup 04

Steering Wheel Control Setup 04

Navigation Operation

> Map Installation 04

> Navi Shortcut 04

Button Color Setup 05

Network Setup

> Wi-Fi Setup 05

> Wi-Fi Hotspot Setup 05

> 3G Dongle Setup 05

Widget and Application Operation

> Download and Install APPS 06

> Calendar Widget 06

> Email 07

Radio Operation

> Radio Basic Operation 08

> RDS 08

> Stores Channel 08

> EQ and FAB Setup 09

Bluetooth Control

> Connecting 10

> Hands-Free Call 11

> Bluetooth Setup 11

> Playing Bluetooth Audio Device 11

Multimedia

> DVD Player 12

> CD Player 13

> Music Player 13

> Video Player 13

Rear Camera 14

Mirror Link 15

Setting Up 19

Wiring Diagram 21

Troubleshooting 23

Basic operation

Definition of the keys

Serial number	name	Functional description
1		When device is working, press and hold about 1 second to power of the system; Short press to mute.
2	MAP	Map card slot
3		Press to turn to home page
4		Return to the previous interface
5		Display navigation interface
6	RADIO	Display the radio interface
7	VOL+ VOL-	Volume up Volume down
8		USB slot
9		Disc insert/eject
10	SD	SD slot
11	Reset (RST / RES)	When the machine is not working properly, press this button and the machine will return to the factory settings.
12		Display the Bluetooth phone screen
13	DVD	Display the DVD interface
14	Video	Play videos from an SD card or USB device
15	Music	Play music from an SD card or USB device
16	Seek 	<ul style="list-style-type: none"> Search the previous chapter or the next chapter Search for the last channel or the next channel
17	Mute	Turn off the sound, button for muting
18	Disc insert slot	Insert the disc into the slot

Note: This table summarizes the definition of most of the panel buttons, but not every model contains all the keys, someThe model contains only a small number of keys, which does not affect the use, if you have questions, please consult the dealer.

Open the system

Press the power button 1 second, activate the system.

Turn off the system

When the system is on, press and hold the power button for 1 second to turn off the system.

[2] RCA output socket

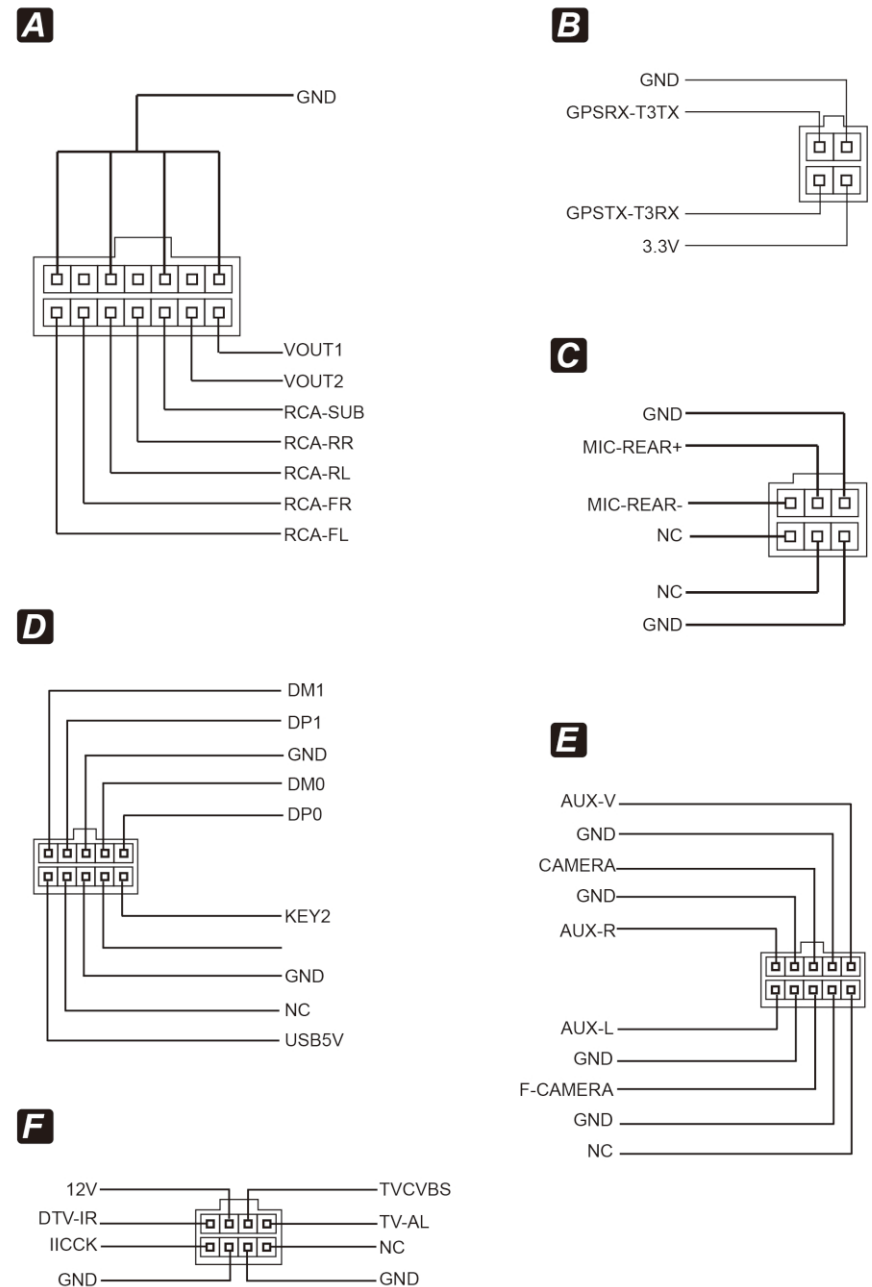

Wiring Diagram

Diagram of power cable and RCA Cable

Note: only work within DC10.5V-16V power
 FM 87.5~108.0MHz
 AM 522KHz~1620KHz
 Speaker prohibit grounding!

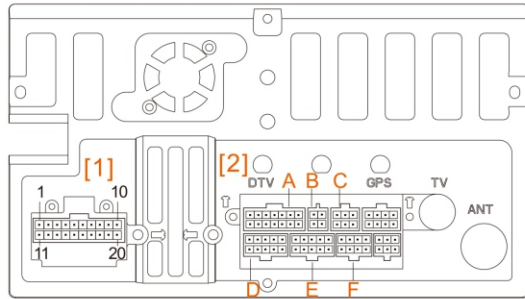

[1] Power Cable Diagram

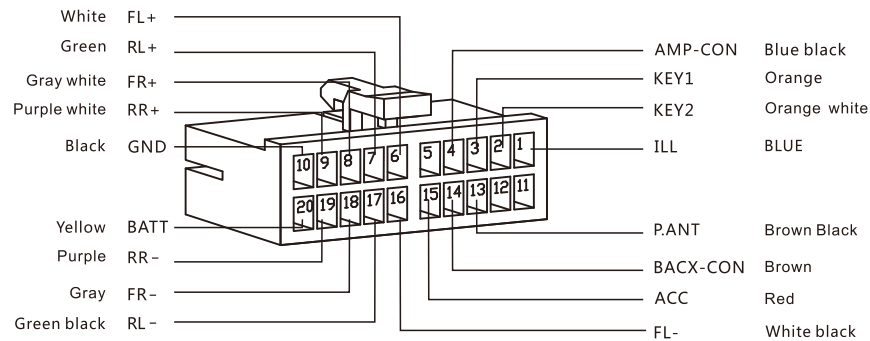

NO.	Network name	Line color
1	ILL	BLUE
2	KEY2	Orange white
3	KEY1	Orange
4	AMP-CON	Blue black
5		
6	FL+	White
7	RL+	Green
8	FR+	Gray white
9	RR+	Purple white
10	GND	Black



NO.	Network name	Line color
11		
12		
13	P.ANT	Brown Black
14	BACX-CON	Brown
15	ACC	Red
16	FL-	White black
17	RL-	Green black
18	FR-	Gray
19	RR-	Purple
20	BATT	Yellow

Operating instruction for main interface



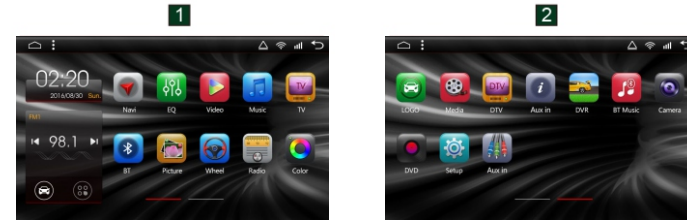

Main interface

1. Press the button . The interface will return to the default main interface.
2. Slide to left or right interface as you want.

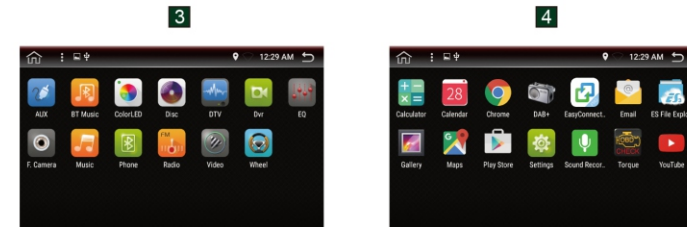

3. Press the button . Car interface will come out. Press the button , it will display the interface of system applications and third-party applications.





4. Press the button , Or long press  or  the Edit menu will come out, press , can replace the main interface wallpaper, press , Go to the widget interface.





number	interface	number	interface
1	Initial media main interface	5	The Menu of Edition
2	Initial Media Main Interface	6	Replace the wallpaper interface
3	The main interface of the car	7	Widget interface
4	System applications and third-party application interface	8	Widget interface

Move or Remove the icons

1. Change the icon position: press and hold the icon, it will pop-up and become larger. This time the icon is movable and you can place it wherever you want.
2. View APP information: press and hold the activated icon, drag the icon  .
3. Delete icon: press and hold the activated icon, drag the icon  .
4. Uninstall the program: press and hold the activated icon, drag the icon  .



Add shortcuts for initial master interfaces 1 and 2



1. Press  or  .
2. Press and hold the icon to wait for the pop-up panel of the main interface 1 and 2 to pop up.
3. Drag the icon to an empty position, and if you drag to other icons, it will form a folder.

Replace the main interface wallpaper

1. Press the button  .
2. Press the Setup icon  , Choose to show
3. Select wallpaper, touch settings wallpaper.

Note: You can also set the wallpaper by referring to the method mentioned in the second page of the manual.

Time and date settings

1. Press the button  , Press the Setup icon  , select Date & Time
2. As shown in the following two ways, choose one.

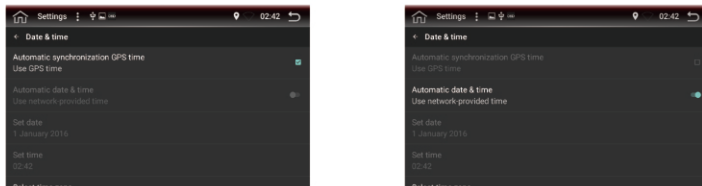

 Back to previous.

About Device

1. Settings >> About Device
2. Enter the device interface, you can view the version information, host memory.

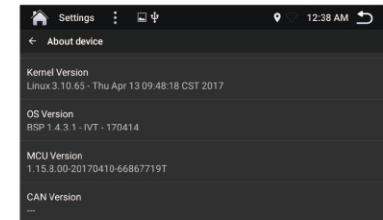
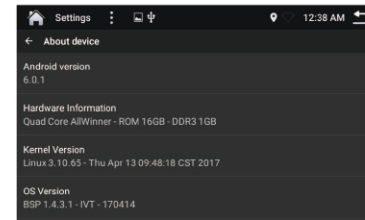
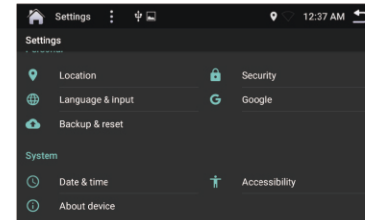

Set up

General settings

Radio area: set >> general settings >> radio area

Button sound: set >> general settings >> button sound >> On/Off

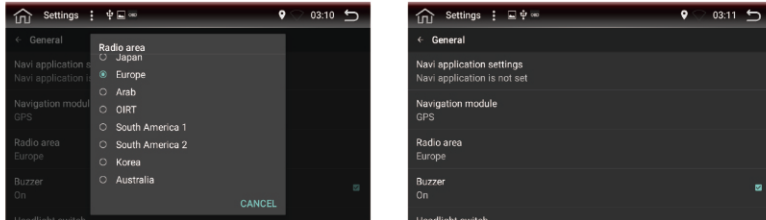

Display

Screen Brightness: settings >> display >> brightness >> adjust the brightness >> confirm

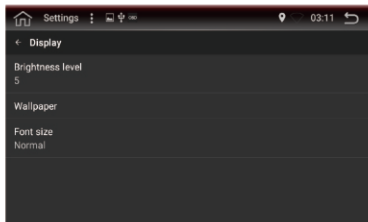

Backup and reset

Back up the files and reset the system.

Set up >> Backup and reset >> reset >> Restore the factory settings

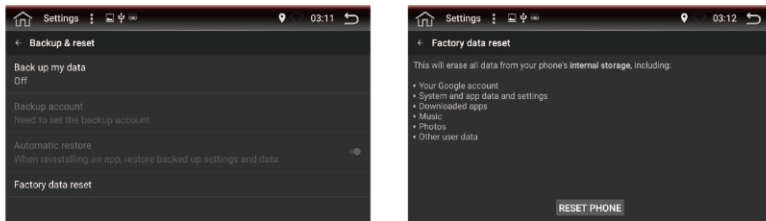

Adjust the date and time manually

1. Touch the <Automatic date & time> and the <Automatic time zone> to remove the check.
2. Touch <Set date>, adjust the date, and touch done.
3. Touch <Set time>, adjust the time, and touch done.
4. Touch <Select time zone>, select a time zone.
5. Press the button.

Start Logo Setup

Touch the , and touch the ES File Explorer , Select your car logo from the USB or SD device. (The image of car logo must be BMP format), click the upper right corner, select Set As Bootlogo

Language Setup

Touch the , and touch the , touch "Language & input", touch Language, select the language and Press the button.

Steering Wheel Control Setup

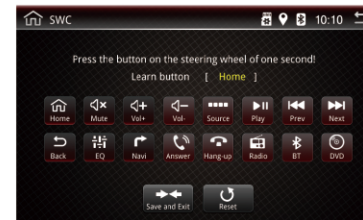

Click into key function learning:

1. Select the function you need.
2. Click your key on the steering wheel.
3. Repeat step 1 and 2 to set other Keys.
4. Press to end.

Remark: if you need to reset the keys, click , then you can set again.

Navigation Operation



Map Installation

1. Copy the Navi file to SD card and put the SD card to the GPS slot.
2. Touch the , and select the ES File Explorer .
3. Touch SD, and select the extsd1.
4. Select the Navi File, and touch the file with suffix name ".apk" and install.

Navi Shortcut

1. GPS Shortcut on the front panel setting
Touch the , and touch the , touch "General", touch "Navi Application Setting", choose the Navi software you prefer.
2. Navi shortcut on the Home Screen
Touch the , and press the Navi software like "Google maps" and drag it to the Navi key on the Home Screen.

Colorful lights set (Optional)

Press the button , Then press the colorful lights , Choose your favorite color, the car's key light color changes. (Note: some model do not support colorful lights function.)



Network Setup

Wi-Fi Setup

Connect to Wi-Fi access

Touch the  >> touch the "Settings"  >> touch Wi-Fi >> turn on the Wi-Fi >> select network >> type password >> connect.

Connect to Wi-Fi hotspot

Touch the  >> touch the "Settings"  >> touch More >> Tethering & portable hotspot >> Set up Wi-Fi hotspot >> enter the Security code >> touch SAVE.

3G Dongle Setup (Optional)

1. Connect the 3G dongle to the USB slot on the back
2. The system will automatically recognize the 3G dongle and connect
3. It connects when the icon  displays on the status bar as picture below.



Note: for the 3G dongle, please buy from the dealer to make sure the 3G dongle works with the unit.

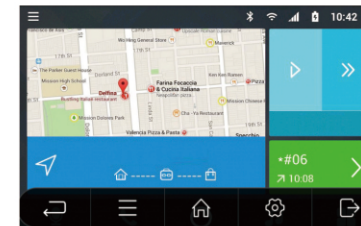
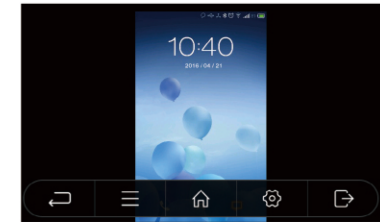
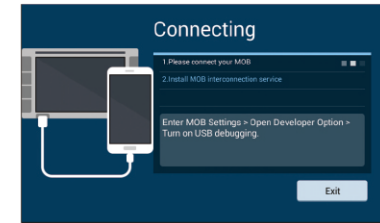
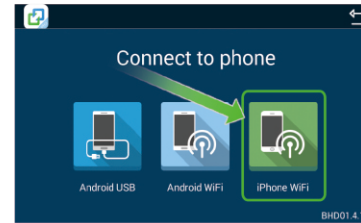

Note: For Wifi connect, must make sure the mobile and the unit is connected to the same wifi. Or make sure the unit is connected the wifi-hotspot of the mobile.

Android 6.0 system supports 4G dongle. The connection of 4G dongle device is consistent with 3G dongle.

iPhone WIFI connect

Turn on the BT of the mobile >>> connect to the BT to the unit >>> BT connected >>>
Touch the easy connect >>> Select the connecting method >>> Connected

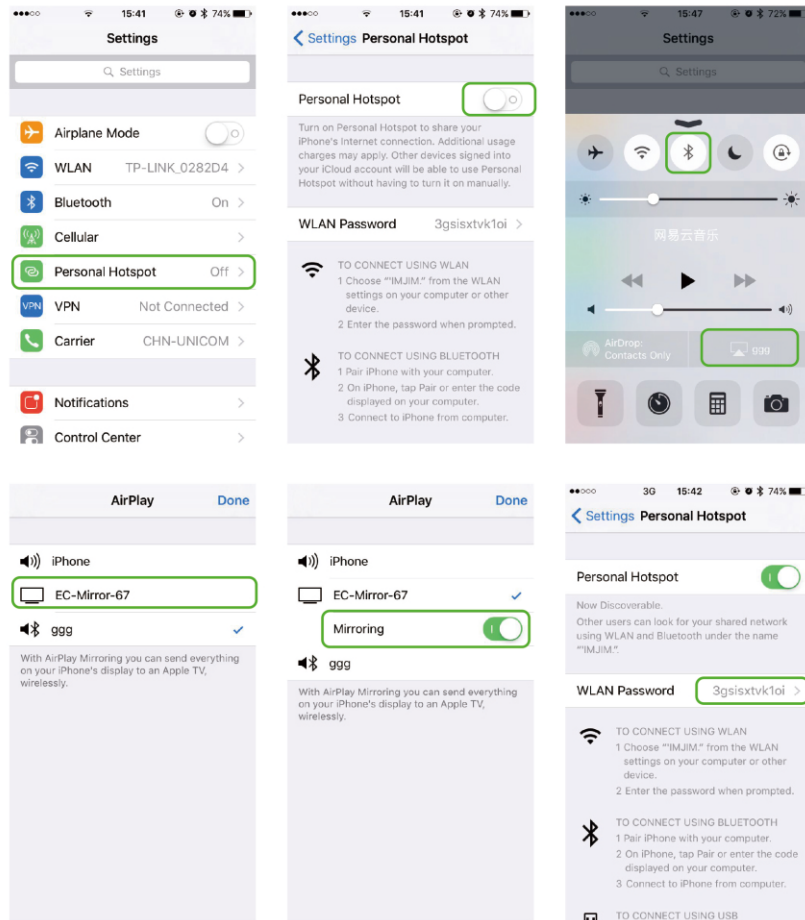
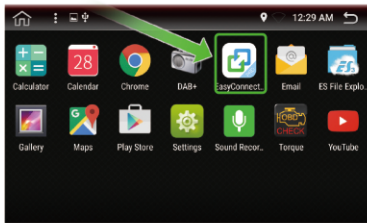

Widget and Application Operation

Install and Uninstall APPS

Install APPS

1. Online install:
connect internet >>> open the browser >>> google.com >>> enter Android Market >>> download the APK file >>> click NEXT to install.
2. USB/ SD install:
download the APK file to the USB >>> connect USB >>> touch the ES File Explorer touch the Local >>> choose USB file >>> select the APK >>> touch to install.

Uninstall APPS

1. Touch the >>> touch the "Settings" >>> touch the Apps >>> select and touch the APP touch uninstall >>> touch OK >>> uninstall finished.
2. Touch and hold the APP icon >>> till the and the shows >>> and drag the APP to the trash >>> touch OK >>> uninstall finished.



Note: the means you can drag the APP to it and uninstall it. If only the displays, it means you can not uninstall the APP, it comes with the system, you can stop use it, but not uninstall it or delete it.

Calendar Widget

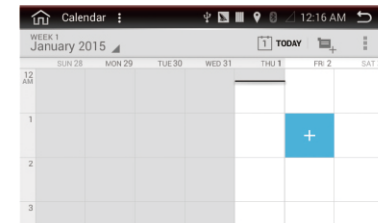
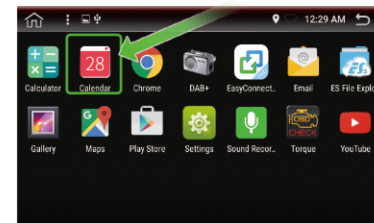
Touch the >>> go to the Widget panel 1 >>> touch and hold the Calendar widget >>> drag to the shortcut panel >>> you can use the calendar widget in the shortcut panel



Email

Touch the  >> touch Email  >> account setup >> enter email address and password >> touch done.

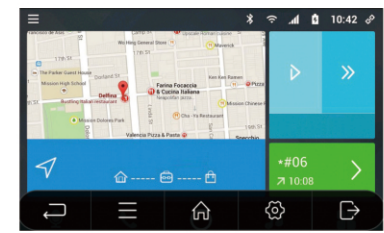
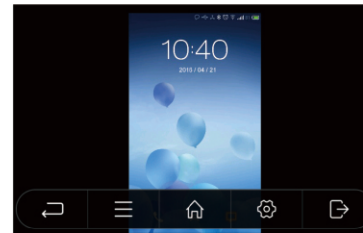
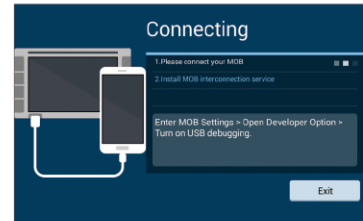
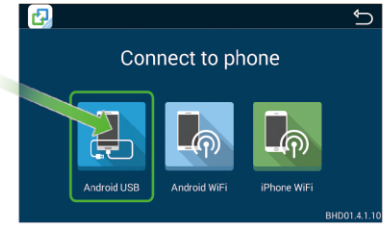
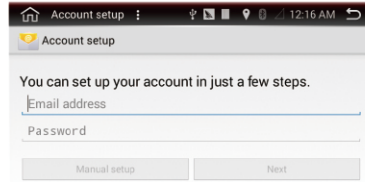

Mirror Link

Note: For android mobile, the USB debugging must be turned on for mirror link function.
And the mirror link not support all android phone, and only support the android mobile that with the USB debugging.

Android USB connect

Find the Developer options of the mobile >> turn on the USB Debugging >> turn on the BT of the mobile >> connect to the BT to the unit >> BT connected >> Touch the easy connect >> Setlect the connecting method >> Connected

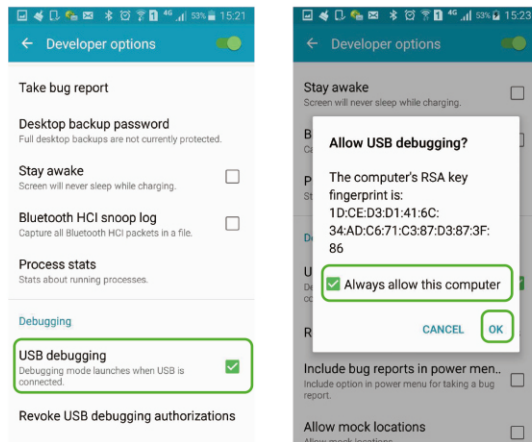
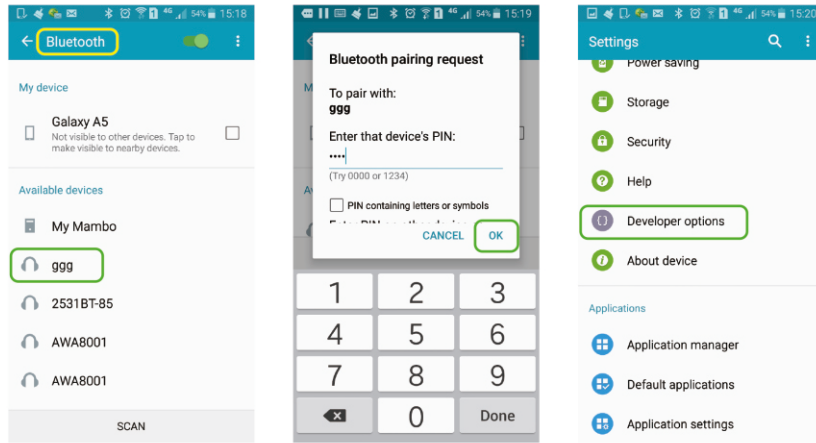

Radio Operation

Radio Basic Operation



1. Select the FM1, FM2, FM3, AM1 or AM2 band
2. Frequency display
 - ◀ switches to previous frequency manually.
 - ▶ switches to next frequency manually.
3. Displays the preset channel list, hold the key (P1-P6) to store the current broadcast frequency.
4. Multi function menu
 - ⏪ ▶ Tunes in a station with good reception automatically.
 - 🔍 Short touch for non stop seek tuning, touch again to cancel. Long touch for switching the preset channels, long touch again to cancel.
 - 📶 Change between Locate and DX mode.
 - ⏮ Press to see more functions.
 - RDS Touch <RDS> to active the RDS function.
 - EQ Touch <EQ> to active the EQ function, pls see the EQ and FAB setting below.
5. Mono and DX
 - DX Displays LOC or DX .
 - Mono Displays Mono or Stereo, decided by the radio IC.

RDS

TP	Shows the traffic station is on or not
AF	Touch AF to light up, RDS can switch to stronger signal frequency when the current frequency is weak, but keep the contents same, only frequency different.
TA	Touch TA to light up, it can source the traffic info every minute, and stops to broadcast the traffic info once news come in.
PTY	Touch PTY to search by type.

Stores Channel

1. Press the P1 key and hold to store the current channel to P1 key.
2. You can save 6 channels at most in this way.

Rear Camera

EQ and FAB setting



1. EQ interface, you can choose sound effects, such as Flat, Pop, Rock, etc.
2. FAB interface, you can choose Loud mode, Bass on/off.

Note: The Reverse cable (pink color) of the power cable must be connected to the car's parking or reversing wire, then parking or reversing, the parking screen will automatically display.

Cable1:
 Red connect with positive wire(B+) of the car back light,
 black connect with the negtive wire(-) of the car back light.



Note: The Reverse Cable is only with the special car dvd for vw, the universal car dvd no need this reverse cable.

Bluetooth Control

CD Player

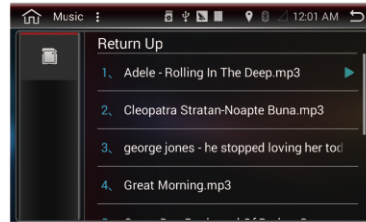

Video Player



Music Player



	Function		Function
	Back to the folder		The last tune
	Pause		The next tune
	Cycle mode		EQ

Note: the Music Player and the Video player works when the USB or the SD card is connected. And there are music or video in the USB or SD card.

Connecting

Registering your Bluetooth device

1. Active the Bluetooth on your phone
2. Touch search to search the Bluetooth waiting for pairing
3. Touch the Bluetooth Device name (jj or other) for connecting
4. Type the pin code (default code is 0000 or 1234) on your phone

Connecting a registered Bluetooth manually

1. Active the Bluetooth on your phone
2. Touch the to see the registered Bluetooth device list
3. Kick the box of the Bluetooth device name to connect
4. Type the pin code (default code is 0000 or 1234) on your phone

Delete a registered device

1. Touch the to see the registered Bluetooth device list
2. Cross the box of the device name
3. Touch the cross, and it tips "Do you want to unpair the Device?"
4. Touch OK, the device deleted

Hands-Free Call

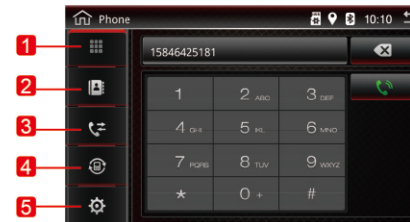

1		Dial Panel
2		Phone book
3		Phone call record
4		Device list
5		蓝牙设置

1) Phone call

Touch the , type the phone number, and click phone call success as screen below, Cancel the phone call by touch the , and touch the to switch to speaker.

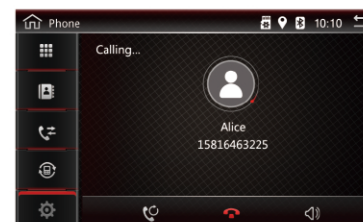

Multimedia

Note: Please remove the screws on the top of the cabinet, before you insert a disc.

DVD Player



	Touch to fast backward, and touch the stop to cancel. Long touch to fast backward 2x, 4x, 8x, and touch to cancel the fast.
	Touch to fast forward, and touch the stop to cancel. Long touch to fast forward 2x, 4x, 8x, and touch to cancel the fast.
	Touch to pause, retouch to continue.
	Stop playing ,return back to default menu
	Touch to the menu play, retouch to the resume.
	Repeat
	Multi-function key , touch to show the options as below
	Touch to set the EQ, same as the EQ in radio screen.
	Touch to choose the language of the subtitle, if the video with different language.
	Touch to choose the video language, if the video with different language choice.
	Touch to select the chapter, enter the chapter and touch ok to go to that chapter.
	Some disc support playing from different angle .
	Info

Note: If tips that " Warning!!! It is illegal to watch video while driving." please go to the setting, select the video, and turn on the driving video. Then the tips will go. But for safe driving, please not watching video while driving.

2) Phone book

Touch the to enter the Bluetooth phone book interface, and follow the to download the phone book.



3) Phone call record



	Dialed call
	Missed call
	Received call

Bluetooth Setup



1. Touch the Bluetooth to change the Name
2. Touch the Pin code to change the PIN code

Playing Bluetooth Audio Device

Click into BT music and play music of the device connected by BT



	The last tune
	The next tune
	Play

FOR-X FOR-X FOR-X FOR-X

ADANA	KOZAN	DOĞAN ELKT.	0.542-489 52 20	CUMHURİYET MH.ANDIL CAD.NO:55
ADIYAMAN	MERKEZ	YÜKSEL ELKT.	0.416-216 63 90	ESKİSARAY MH.GÖLEBATMAZ CD 710 SK NO:10/A
ADIYAMAN	MERKEZ	TEPE ELKT.	0.542-734 14 74	TURGUT REİS MH.ESKİ ZEY YOLU116 SK.NO:3
ADIYAMAN	BESNİ	ARSLANTAŞ ELKT.	0.416-318 05 91	YENİ BESNİ MH ESKİ ADIYAMAN YOLU CD NO.7
AFYONKARAHİSAR	EMİRDAĞ	KAHRAMAN ELKT.	0.272-442 81 10	YENİ MAH.LİSE CAD.NO:5
AFYONKARAHİSAR	MERKEZ	BARBAROS TEKNİK	0.272.215.12.17	MARULCU MH AÇIKGÖZÖĞLU SK NO.18/A
AKSARAY	MERKEZ	DÜNYAM ELKT.	0.382-212 72 53	ATATÜRK BULV PAŞACIK MH NO.2 OKUR APT ALTI
AMASYA	MERKEZ	YÖNDEN ELKT.	0.358-212 97 96	ATATÜRK CD GÜMÜŞLÜ MH 11/B
AMASYA	MERZİFON	MERT ELKT.	0.358-513 83 61	HARMANLAR MH.HARMANLAR PASAJI NO:34
ANTALYA	MERKEZ	ESEN ELKT.	0.242-244 13 18	100.YIL BLV.ALTINDAĞ MH.163 SK.YILDIZ APT.NO:16/3D
ANTALYA	DÖŞEMEALTI	UZMAN ELKT.	0.242-421 43 56	ATATÜRK CAD.BAHÇEKAYA MH.NO:132/A
ANTALYA	ALANYA	ŞAHİN ELKT.	0.242-513 51 42	HACET MH BÜYÜKHASBAHÇE CD AKDENİZ APT. NO:13/D
ANTALYA	DOKUMA	YAŞAR ELKT.	0.242-334 01 13	ULUS MH.MEHMET AKİF ERSOY CAD.ÇAĞLAR APT.NO:14/B
ANTALYA	KAŞ-KALKAN	KALKAN ELKT.	0.242-844 10 03	MENTEŞE MH.GÜL SK.NO:48/B
ANTALYA	MANAVGAT	ÖZÇELİK ELKT.	0.242-742 34 38	YAYLA MH FEVZİ GÜVEN CD NO.118/Z1
ANTALYA	SERİK	GÖKTÜRK ELKT.	0.242-722 70 53	SANAYİ SİTESİ 5.BLOK NO:4
AYDIN	EFELER	BİLGİN ELKT.	0.256-213 18 45	ATA MH BİRİNCİ SAN SİT 615 SK NO:1
AYDIN	SÖKE	KARADAĞ ELKT.	0.536.658.25.50	KEMALPAŞA MH.ALKAN SK.NO:3/B
AYDIN	NAZİLLİ	KAĞAN ELKT.	0.256-312 55 45	ZAFER MH ALBAY İ.KARAOĞLAN CD NO.62/A
AYDIN	KUYUCAK	SİSTEM ELKT.	0.256-371 32 88	AYDINOĞLU MH.ALBAY MUSTAFA DURGUN SK.NO:7
AYDIN	BUHARKENT	OKUMUŞ ELKT.	0.256-391 22 37	ÜÇ EYLÜL MAH.12.SK.NO:9/B
BALIKESİR	BİGADIÇ	GÜÇLÜ ELKT.	0.542-773 06 26	SERVİ MH HİTAY CD TOPATAN ÇIKMAZI NO.6
BALIKESİR	BANDIRMA	TDM TEKNİK	0.266.713.00.25	İHSANİYE MH. HASTANE SK NO.8/A
BARTIN	MERKEZ	AKIN ELKT.	0.378-228 33 34	KIRTEPE MH.HAMAM SK.NO:22
BAYBURT	MERKEZ	DOĞAN ELKT.	0.458.210.85.04	UNUTULMAZ CAD.GUKKU SK.NO:5
BİNGÖL	MERKEZ	ÇÖZÜM ELKT.	0.426-214 63 62	YENİŞEHİR MH.ÖZGÜRLÜK CD.GÜLTEPE SK.NO:3
BİTLİS	GÜROYMAK	FURKAN ELKT.	0.434-511 21 75	ÜZÜMVEREN CAD.DEMİRCİLER SK.
BOLU	MERKEZ	ÇAĞDAŞ ELKT.	0.374-212 52 84	AKTAŞ MH.TAŞANCILAR CAD.NO:14/B
BOLU	MERKEZ	EDA ELKT.	0.374-215 09 97	KARAMANLI MH.KONURALP CD.ÇELİK AĞ APT.NO:3/E
BURDUR	MERKEZ	ALBAYRAK ELKT.	0.248-234 37 90	KONAK MH.OĞUZ SK.NO:17
BURSA	YENİŞEHİR	ALFA ELKT.	0.224-772 15 77	YENİGÜN MH.BURSA CAD.NO:30
BURSA	ORHANGAZİ	CEM ELKT.	0.543.485.28.55	CAMİKEBİR MH.RECEPZADE SK.NO:10/D
BURSA	İNEGÖL	BURAK ELKT.	0.224-715 14 48	SİNAN BEY MH.SİNANBEY CAD.NO:15
BURSA	NİLÜFER	TORUL ELEKTRONİK	0.224.244.99.60	A.YESEVİ MH. BALAT CD. NO:3/B
ÇANAKKALE	MERKEZ	YILMAZ ELKT.	0.286-213 11 65	İSMETPAŞA MH.DORUK SK NO:13/B
ÇANAKKALE	GELİBOLU	GÜVEN ELKT.	0.286-566 90 70	CAMİKEBİR MH.PAZARYERİ 3.SK.NO:27

FOR-X FOR-X FOR-X FOR-X

ÇORUM	OSMANCIK	DEKA ELKT.	0.364-611 73 02	ULU CAMİ MH.ULU CAMİ SK.NO:8/B
DENİZLİ	MERKEZ	DENİZLİ ELKT.	0.258-241 03 73	UÇANCIBAŞI MH.586 SK.NO:1
DENİZLİ	HONAZ-KAKLIK	KAYA ELKT.	0.258.816.21.12	İSTİKLAL MH.ÇARŞI CAMİ KARŞISI NO:20/B
DIYARBAKIR	MERKEZ	DÜNYA ELKT.	0.412-228 01 40	S.NAZİF MELİK AHMET CD. 11/61 ESKİ JAPON PSJ YANI KT:2
DIYARBAKIR	SILVAN	GALİP ELKT.	0.412-711 64 80	GAZİ CD.ASAYIŞ BÜRO AMİRLİĞİ YUKARISI NO:7
DÜZCE	MERKEZ	BEST ELKT.	0.380-514 62 81	ÇAY MH.SAATÇIĞILCD NO:19
EDİRNE	KEŞAN	ÇAĞIN ELKT.	0.284-714 90 30	ALİ PAŞA HALK ÇARŞISI NO:101
ELAZIĞ	MERKEZ	ÇOŞKUN ELKT.	0.424-218 27 52	YENİ MH.M.ÇORBACIOĞLU SK.NO:47/C
ERZİNCAN	MERKEZ	ZİRVE ELKT.	0.446-223 88 99	MERKEZ ÇARŞISI 5. SK NO.22
ERZURUM	MERKEZ	ES ELKT.	0.442-242 23 82	50.YIL CD.CUMHURİYET LİSESİ YANI NO:14
ERZURUM	OLTU	GÖZÜTOK ELKT.	0.541-242 33 43	ASLANPAŞA MH.ATATÜRK CD.BELEDİYE BİNASI KARŞISINO:3
ERZURUM	YAKUTİYE	DİJİTAL ELEKTRONİK	0.536.375.69.47	EVREN PAŞA MH. İBRAHİM HAKKI CD. YAKUTİYE KAYM KAR
ESKİŞEHİR	MERKEZ	IŞIK CAR AUDIO	0.222-224 10 00	BAHÇELİEVLER MH. SEYLAPO CD. 58/A
GAZİANTEP	MERKEZ	HİTS ELKT.	0.342-230 77 35	ALLEBEN MH.KARACAOĞLAN SK.NO:7/A
GAZİANTEP	NİZİP	AKKUŞ ELKT.	0.342-518 09 52	SAHA MH.SABANCI PAZARI NO:46
GİRESUN	MERKEZ	AYARLAR ELKT.	0.454.216.10.56	HACI SİYAM MH.İNÖNÜ CD.NO:85/C
HATAY	ANTAKYA	DETAY ELKT.	0.542.402.22.22	RAÇAN SİT. G.BİRLİK MH. Y.EMRE CD. YENİ SAN SİT. 1.ADA
HATAY	İSKENDERUN	KIZILNAR ELKT.	0.326-613 69 66	KURTULUŞ MH.ŞEHİT OĞUZ YENER CD NO.58
HATAY	KIRIKHAN	ŞENER ELKT.	0.535-545 15 43	GÜNDÜZ MH BAYIRBUCAK CD NO.14/A
HATAY	REYHANLI	BAHADIR ELKT.	0.326-413 22 83	CUMHURİYET MH.KÖKLÜ BAHADIR İŞANİZEMİN KAT NO:1
HATAY	DÖRTYOL	AYDIN ELEKT.	0.542 779 54 28	ALTINÇAĞ MH. KIRIKÇI SK NO:9
HATAY	SAMANDAĞ	BİLİM ELKT.	0.326-512 95 74	ATATÜRK CAD.ATATÜRK MH.NO:68/A
İĞDIR	MERKEZ	AKÇAY ELEKTRONİK	0.476-227 15 54	TANSU ÇİLLER CD.AZER SK.NO:19
İSPARTA	MERKEZ	SOYÇİÇEK ELKT.	0.246-232 76 04	PİRİ MEHMET MH.1760 SK.NO:12
İSTANBUL	MAHMUTBEY	MERDAN ELEKTRONİK	0.212.659.83.88	İSTOÇ 34. ADA NO.18/20
İSTANBUL	GÜNGÖREN	BİROL ELKT.	0.212.641.17.51	AKINCILAR MH.POSTA CD.NO:55
İSTANBUL	SULTANGAZİ	KARDEŞLER ELKT.	0.212-536 52 28	YUNUS EMRE MH.YUNUS EMRE BLV.NO:11
İSTANBUL	BEYKOZ	SİNEM ELKT.	0.216-323 32 33	ORTAÇEŞME MH.ÇAYIR CD.BELEDİYE DÜKKANLARI NO:90/1
İSTANBUL	PENDİK	ZİRVE ELKT.	0.532-493 27 10	BATI MAH. HATBOYU CAD.NO:36 D3
İSTANBUL	ARNAVUTKÖY	FLAŞ ELKT.	0.212-597 18 60	MERKEZ MH.FATİH CD.NO:127/C CÖMERT PASAJI ALTI
İSTANBUL	SULTANGAZİ	KIRMIZIGÜL TEKNİK	0.212.476.81.35	İSMETPAŞA MH. 95 SK NO:6/A
İSTANBUL	GÜNGÜÖREN	HKN ELEKTRONİK	0.212.434.58.80	GÜNEŞTEPE MH. HUZUR SK NO.1
İSTANBUL	KARTAL	FULLTECH BİLİŞİM	0.216.372.63.63	CEVİZLİ MH. DENİZER CD. TUNCELİ SK NO:20/D
İSTANBUL	SULTANBEYLİ	KARADENİZ ELEKT.	0.216.487.37.37	AKŞEMSETTİN MH. SUKENARI CD. NO:4/A
İZMİR	TİRE	YÜKSEL ELKT.	0.535-374 22 89	YENİ MH.ATATÜRK CD.NO:103
İZMİR	ÖDEMİŞ	METEOR ELKT.	0.232-544 05 06	ORDU CAD.NO:11/A

FOR-X FOR-X FOR-X FOR-X

FOR-X FOR-X FOR-X FOR-X

FOR-X FOR-X FOR-X FOR-X

İZMİR	KARŞIYAKA	ÖNCÜ ELEKTR.	0.232.364.00.51	1675 SK NO:126
KAHRAMANMARAŞ	12.Şub	AKDOĞAN ELEKTRONİK	0.344.-235 15 85	KÖY GARAŞI ÇAŞİBEYMH.3.TOPTANCIKLAR BLOK NO:40
KAHRAMANMARAŞ	ELBİSTAN	FLASH ELKT.	0.546.-236 99 88	CEYHAN MAH.CUMHURİYET CAD.TOKUÇOĞLU SK NO:92/B
KARAMAN	MERKEZ	STAR ELKT.	0.338-213 21 11	YUNUS EMRE CAD.DEVRANOĞLU İŞHANI NO:15
KARABÜK	MERKEZ	ÇAĞ ELKT.	0.532-747 57 55	HÜRRİYET MH.İNÖNÜ CAD.FATİH ÇARŞISI KAT:1 NO:8
KAYSERİ	MERKEZ	AKIŞ ELKT.	0.352-320 14 00	AYDINLIK EVLER MH.CENGİZ TOPEL CD.NO:20/B
KAYSERİ	MERKEZ	ATOM ELKT.	0.352-331 20 76	YENİ SAN.BÖL.5.CAD.58.SK.NO:3/A
KIRIKKALE	MERKEZ	ÖMÜR SOUND	0.543.445.51.58	TEPEBAŞI MAH.MEHMET AKIF CAD.NO:13/C
KIRKLARELİ	LÜLEBURGAZ	YILDIZ ELKT.	0.288-413 00 39	ESKİ EDİRNE CAD.DERE MAH.DERE SK NO:61/2
KIRKLARELİ	PINARHİSAR	HASAN ELKT.	0.288-615 35 78	DERE MH.İSMET AGAN CAD.NO:37/A
KIRŞEHİR	MERKEZ	YASİN ELEKTRONİK	0.546.402.86.19	KUŞDİLİ MH. 1.ÇARŞI TOKMAKÇILAR İŞHANI NO:12/D
KİLİS	MERKEZ	TEKNİK ELKT.	0.348-813 75 58	TABAKHANE MH.SALİH AĞA ÇEŞME SK.NO:31
KOCAELİ(İZMİT)	DİLOVASI	SAMET ELKT.MERKEZ	0.262.754.79.86	MİMAR SİNAN MH İSTİKLAL CD NO.15
KOCAELİ(İZMİT)	GEBZE-DARICA	DENİZ ELKT.	0.532-697 70 59	ABDİ İPEKÇİ MH.ETHEM BEY CAD.NO:51
KOCAELİ(İZMİT)	KARAMÜRSEL	KILINÇ ELKT.	0.262-452 55 55	İNÖNÜ CAD.M.YASEF SK.NO:10/M
KONYA	SELÇUKLU	METAL ELEKTRONİK	0.554.484.90.64	KOSOVA MH İFTİHAR SK NO.3/C
KONYA	SEYDİŞEHİR	LİDER ELKT.	0.506.496.93.85	ULUDAĞ CAD.HANBOĞAZI MEVKİİ NO:13/C
KONYA	AKŞEHİR	AS ELKT.	0.332-813 44 93	MEYDAN MH.BUĞDAY SK.NO:4
KONYA	EREĞLİ	STAR ELKT.	0.530-223 03 32	HAMİDİYE MAH.BUĞDAY PAZARI CAD.2.BELEDİYE İŞ MRK.NO:18/C
KONYA	BEYŞEHİR	BARİŞ ELKT.	0.332-512 40 06	DALYAN MAH.ATATÜRK CAD.ÖZTÜRK İŞHANI NO:11/A
KÜTAHYA	MERKEZ	KARDEŞLER ELKT.	0.274-212 09 57	LALA HÜSEYİN PAŞA MH.KIBRIS CAD.NO:61/B
KÜTAHYA	SİMAV	ORJİNAL ELKT.	0.274-513 33 99	4 EYLÜL MAH.TEVFİL FIKRET CAD.NO:9/C
KÜTAHYA	TAVŞANLI	ÜSTÜN ELKT.	0.536-425 46 12	KAVAKLI MAH.CUMHURİYET CAD.NO:29/A
MALATYA	MERKEZ	SİMGE ELKT.	0.422-326 46 71	SARAY MH.SARAY SK.NO:36
MANİSA	MERKEZ	DARCAN ELKT.	0.236-237 23 83	75.YIL MH 5311 SK NO.17/A KENANEVREN SAN SİT
MANİSA	ALAŞEHİR	GÖKKUŞAĞI ORT ELEK	0.236.653.96.60	SOĞUKSU MAH.İSMET PAŞA CAD.NO:124
MANİSA	ALAŞEHİR	ÜÇLER ELKT.	0.236-653 42 71	5 EYLÜL MH MİLLİ EĞEMENLİK CD NO.34/A
MANİSA	SARIGÖL	KARAÇAM ELKT.	0.536.870.75.45	AYAN MH.UZUNKUYU SK.NO:1/C
MERSİN	MERKEZ	MERDAN ELEKTRONİK	0.324-324 43 29	H.OKAN MERZEÇİ MH.219.CAD.NO:179
MERSİN	TARSUS	PARÇA ELKT.	0.324-624 91 25	HİLMİ SEÇKİN BULVARI ALPAY APT.ALTİ
MERSİN	TARSUS	UYAR ELKT.	0.324-624 01 54	KIZILMURAT MAH.ŞAHMERAN SK.NO:6
MERSİN	ERDEMLİ	ÇEVİK ELEKTRONİK	0.324.515.46.05	MERKEZ MH Ş.ÖMER SERİN SK NO:20
MERSİN	BOZYAZI	NET ELKT.	0.324-851 36 66	ATATÜRK CAD.SAYDAM PASAJI NO:18
MERSİN	MUT	LİDER ELKT.	0.324-774 03 76	PINARBAŞI MAH.KOÇA HACI SK.NO:2/A
MUĞLA	FETHİYE	İLERİ ELKT.	0.252-612 00 92	ATATÜRK CAD.FETHİYE ŞÖFÖRLER CEMİYETİ ALTINO:67/A
MUĞLA	MİLAS	BİLGE ELKT.	0.252-512 61 98	GÜMÜŞKESEN CAD.NO:4/B

FOR-X FOR-X FOR-X FOR-X

MUĞLA	DALAMAN	DAĞLARBAŞI ELKT.	0.252-692 25 22	ŞEHİT KARAOĞLANOĞLU CAD.KARAÇALI MH NO.42
MUĞLA	DALAMAN	UFUK ELEKTRONİK	0.850.885.02.82	MERKEZ MH ATATÜRK CD. 85/B
MUĞLA	KÖTEKLİ	ÇAĞDAŞ ELKT.	0.252-223 86 13	KÖTEKLİ MH S.KOÇMAN CD TURHAN APT NO.106/B
MUĞLA	BODRUM	ÖZEN ELKT.	0.252-373 62 63	YENİ MAHALLE MENDERES BULVARI NO:51/B MUMCULAR
NİĞDE	ÇİFTLİK	YAĞMUR ELKT.	0.388-411 26 73	ÇARŞI MAH.MEDAŞ YANI NO:2
ORDU	MERKEZ	CEREN ELKT.	0.452-233 22 42	YENİ MAH.KAHRAMAN SAĞRA CAD.NO:119/B
ORDU	FATSA	UÇAR ELKT.	0.452-423 84 21	D.PINAR MH. İPEKÇİ CAD. NO:2/A
OSMANİYE	MERKEZ	AS TEKNİK ELKT.	0.328-813 96 14	CUMHURİYET MAH.K.KARABEKİR CAD.NO:79/B
OSMANİYE	DÜZİÇİ	EMRE ELKT.	0.328-876 33 62	İSTİKLAL MH ÇERÇİOĞLU SK NO:15/2
OSMANİYE	KADIRLI	BİLLUR ELKT.	0.328-717 60 40	PAZAR MAH.15 SK.NO:1/A
RİZE	MERKEZ	BENİM USTAM ELKT.	0.464-253 04 53	EKREM ORHAN MH.TÜRK TELEKOM ARKASI GÜL SK.NO:7/A
SAMSUN	MERKEZ	DİJİTAL ELKT.	0.362-234 01 31	ÇİFTLİK MAH.100.YIL BLV.NO:215/C
SAMSUN	MERKEZ	LEVENT TİCARET	0.362-420 00 03	FATİH MH.GEBİ CAD.NO:86
SAMSUN	ÇARŞAMBA	DİJİTAL ELKT.	0.362-833 96 91	KIRAZLIK ÇAY MAH.DEĞİRMENBAŞI CAD.NO:26 BATIYAKA
SAMSUN	BAFRA	AYDOĞAN ELKT.	0.362-543 17 44	TABAKHANE MAH.KAPTAN GEÇİDİ NO:8/C
SIĞIRCI	MERKEZ	ERYILMAZ ELKT.	0.484-224 03 92	CUMHURİYET CAD.ULU CAMİ KARŞISI NO:25
SINOP	MERKEZ	ÖZEN ELKT.	0.368.216.53.23	CAMİ KEBİR MAH.İŞCAN PASAJI NO:9
SİVAS	MERKEZ	TURKUAZ ELKT.	0.507-991 13 53	KIZILIRMAK MH.YAHYABEY CD.DOĞANTAŞ APT.ALTİ 65/A
ŞANLIURFA	MERKEZ	ÖZEN ELKT.	0.541.713.53.63	ATATÜRK MH ASFALT CD NO.43
ŞANLIURFA	BİRECİK	YENİCE ELKT.	0.535-353 62 70	KURTULUŞ MH.URFA KAPISI NO:7/B
TEKİRDAĞ	MERKEZ	KARDEŞLER ELKT.	0.282-264 26 25	GÜNDOĞDU MH.KÖSELYAS CAD.NO:9/B
TOKAT	MERKEZ	KARAKAŞ ELKT.	0.356-214 87 79	TEVFİK PAŞA CAD.SARAY ÖNÜ NO:47
TOKAT	MERKEZ	AKINCI ELKT.	0.356-212 56 00	ALİ PAŞA MAH.BEHZAT BLV.26.SK.NO:4
TOKAT	ZİLE	KARSLIOĞLU ELKT.	0.356-317 99 20	CEDİT MH UZUNÇARŞI SK NO.83
TOKAT	ERBAA	YILDIRIM ELKT.	0.356-715 17 70	İSMET PAŞA MH DR SERMET DURMUŞOĞLU CD PTT YANI KAYALAR İŞ MERKEZİ NO:18
TRABZON	MERKEZ	DOSTLAR ELKT.	0.462-321 48 37	CUMHURİYET MAH.NEMLİOĞLU CEMAL SK.NO:6
UŞAK	MERKEZ	ATAK ELKT.		SARAY ALTI MAH.CELAL BAYAR CAD.NO:25/A
UŞAK	EŞME	BİLGİN ELKT.	0.276-414 26 49	ŞEHİT ALİ BEY MAH.HAL CAD.ÇARŞI CAMİ ALTI NO:Z/3
VAN	ERCİŞ	SİSTEM ELKT.	0.432-351 78 68	ZÜBEYDE HANIM CAD.NO:4
YOZGAT	SORGUN	GOLD ELKT.		AGAŞ EFENDİ MAH.CUMHURİYET CAD.NO:26
ZONGULDAK	EREĞLİ	ALPER ELEKTRONİK	0.372.322.51.00	MURTAZA MH ALİ RIZA OĞUZ SK NO:1/C

FOR-X FOR-X FOR-X FOR-X

FOR-X FOR-X FOR-X FOR-X