

FOR-X

www.for-x.com.tr

Owner's Manuel

XQ-7452DSP DIGITAL MEDIA RECEIVER



App Store



Google Play

CE

CONTENTS:

Warnings&Precautions	01
Product Features	01
Installation	02
Accessory List	03
Dimension(Unit:mm)	03
Wiring Diagram	04
Basic Functions Of Panel Keys	05
Remote Operation	06
APP Operation	06
Radio Operation	07
USB&SD Playback	07
Bluetooth Operation	08
External Microphone	09
Audio Settings	10
Xover Setup	11
Animation Settings	15
Demo Mode Select	15
DTA Setup	16
Time Alignment(Distance)	18
Clock And Date Settings	19
Tuner Settings	19
Display Settings	20
Trouble Shooting	21
Speaker Connection	21
Specification	22

WARNINGS & PRECAUTIONS:

To avoid risk of serious injury or possible violation of laws, please read the following thoroughly before installation or connecting.

- This product is designed specifically for use with 12 volt, negative ground electrical systems only.
- Having the wiring and installation done by expert.
Be sure to disconnect the cable from the negative battery terminal while installtion.
- This apparatus shall not be exposed to dripping or splashing, and no object filled with liquids shall be placed on the apparatus.
- Fuses shall be replaced only with the correct type and fuse value, and only when the apparatus is powered off.
- To prevent a short circuit, never put or leave any metallic objects(such as coins or metallic tools)inside the unit.
- Never set the volume of this product so high that you cannot hear outside traffic and emergency vehicles.

PRODUCT FEATURES:

Panel: Fixed

LCD:VA-LCD

Key Light: Multi Color

Bluetooth: Version 5.0

Bluetooth Music: Support

DSP: Built-in

EQ: 28 Band,8 Preset

Pre-Output: 8CH x 4V

Max Power: 4 x 100W

Xbass: Support

Xover: Support

3D Surround: Support

2-Way Network: Support

3-Way Network: Support

Time Alignmnet: 0-18 ms

Q Value: 1-20

Subwoofer Control: Support

Playback Interface: TF & USB

Phase: 0°-180°

Listening Bit Setting: Support

Slope: Support

PAC™-SWI: Support

Remote: Support

Microphone: Built-in and External

Radio: Preset 18FM, 12AM, RDS

APP Control: iOS and Android Phone

Charge: Rear USB 2A

Audio Format: MP3, WMA, AAC, FLAC, APE

INSTALLATION

Installation Procedures

First complete the electrical connections and then check for correctness.

Installation Opening

This unit can be installed in any dashboard Having an opening as shown below:

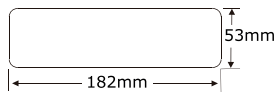

TO Install The Car Radio

Be sure you test all connections first, and then follow these steps to install this unit.



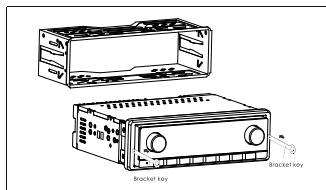



1. Make sure the ignition is turned off, and then disconnect the cable from the vehicle battery' s negative (-) terminal.
2. Disconnect the wire harness and the antenna.
3. Remove the detachable panel and decorative enclosure frame and place on one side.
4. Insert the two brackets into the left and right sides of the chassis, as shown in the following figure, and separate the chassis from the sleeve.

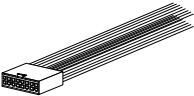

5. Insert the installation sleeve into the center console to be installed, and bend the clip using a screwdriver. Make sure the locking rod is flush with the mounting sleeve and does not protrude.
6. Connect cables as shown in the Wiring diagram.
7. Insert the car radio into the mounting sleeve.
8. Install decorative enclosure frame.

ACCESSORY LIST:

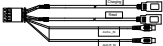
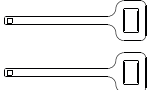
Please check the following accessories after opening the package:

<p>16P scatter line</p> 	<p>Remote x1</p> 	<p>Frame x1</p>  <p>Install on the host</p>	
<p>Half sleeve x1</p>  <p>Install on the host</p>	<p>10P expansion cable</p> 	<p>Diassemble keys x2</p> 	<p>User Manual/Warranty Card/ Service Manua</p> 

DIMENSION(UNIT:MM):

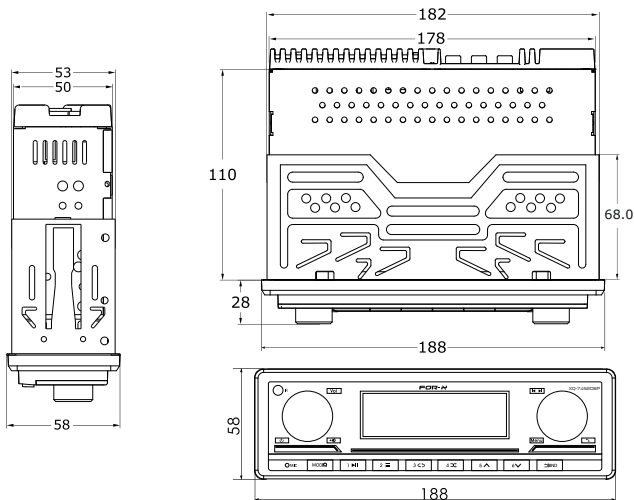

WIRING DIAGRAM:

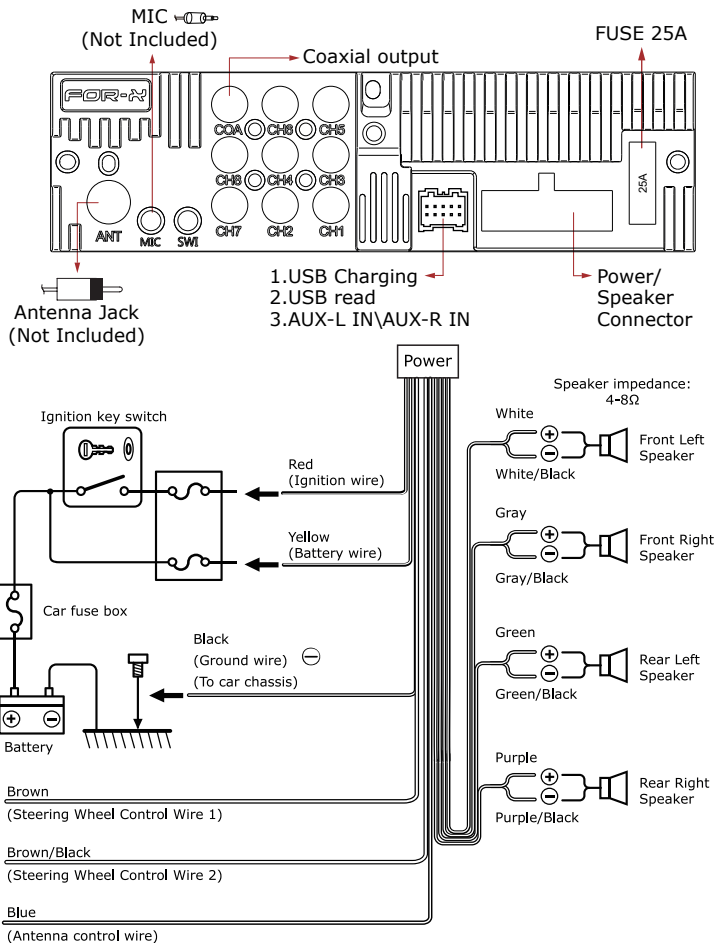

BASIC FUNCTIONS OF PANEL KEYS:

To	Radio status	USB/TF/BT MUSIC Status
◀ ▶	Seek a station manually	Previous/Next track
1 ▶	Preset 1	Playback/Pause
2 ≡	Preset 2	Intro Playback
3 ↻	Preset 3	Repeat Playback
4 ⌘	Preset 4	Random Playback
5 ^	Preset 5	Previous folder
6 v	Preset 6	Nefolderxt
↶/BND	Return/Band Select	
⏻ 🔊	Press to mute, Press and hold to power off	
MOD/Q	Press to select a source/Press an hold to auto memory	

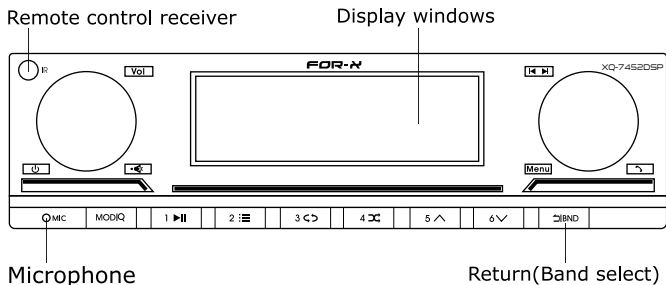

REMOTE OPERATION:

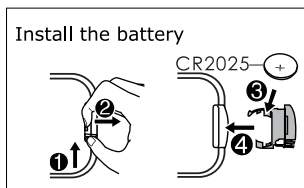
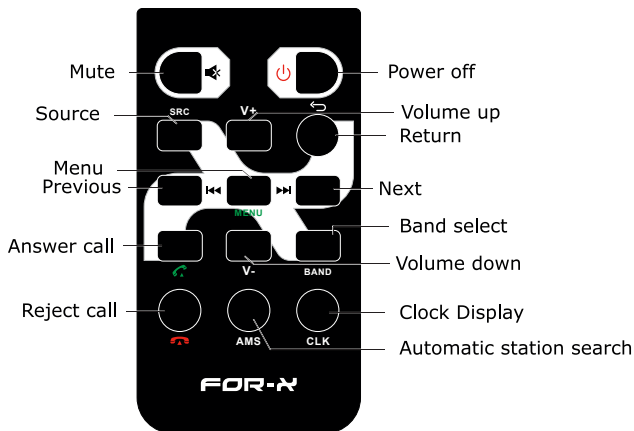

APP OPERATION:

APP Download

Method 1: Please scan the QR code on the cover to download the APP and install it on your Android or Apple device.

Method 2: Please go to the APPLE APP Store or Google Play Store and search [AUDIO DSP Control] APP, after downloading the APP, install it on your Appale&Android devices.

APP Connection

1. Open the [AUDIO DSP Control] APP, click [🔍] to search for XQ-7452DSP
2. Click XQ-7452DSP to connect, the [🟢] will be red after the connect is successful.

RADIO OPERATION:

Start Listening

To	Operation (panel)	Remark
Auto memory	Press and hold MOD/Q	18 FM/12AM
Band selection	Press ↔/BND	FM1/FM2/FM3/AM1/AM2
Seek a station manually	Rotate the right knob ◀ ▶	
Search the next or previous frequency step by step	Rotate the right knob ◀ ▶	
Store a station	Press and hold 1-6	

RADIO	
FM Frequency Range	Europe Area: 87.5 ~ 108.0 KHz (50KHz / Step)
	U.S.A.Area: 87.5~107.9 KHz (200 KHz / Step)
	ASIA Area: 87.5~108.0 KHz (100 KHz / Step)
	RUSS Area: 65.0 ~74.0 KHz (30 KHz/ Step)
Preset	18FM / 12AM

USB&SD PLAYBACK:

To	Operation (panel)
Track selection Fast playback	Rotate the right knob ◀ ▶
Playback/Pause	Press 1/▶
Track pre-play	Press 2 :≡
Repeat playback	Press 3 ↔ • REPEAT ONE.REPEAT DIR.REPEAT ALL
Random playback	Press 4 ⌘ • ON/OFF
Folder selection	Press 5 ^ 6 ∨

BLUETOOTH OPERATION:

Bluetooth Pairing



The first time pair mobile phone with receiver, please follow below steps:

1. When there is no pairing, in any mode, the BT on the LCD will flash, and the pairing can be performed at this time.
2. Turn on the phone's Bluetooth to Search XQ-7452DSP
3. Click on the XQ-7452DSP on the phone to connect. After the connection is successful, the BT will stop flashing.
4. When pairing is complete, the mobile phone audio will automatically transfer to the car audio system whenever a call is made or received, or when the mobile phone plays music.



Note:

For more details of bluetooth pairing, please refer to the owner's manual for your mobile phone.

Bluetooth Basic Operation

To	Operation (panel)
Make a call	Bluetooth mobile phone connected
Answer a call	Press the right knob 
Reject an incoming call	Press and hold the right knob 
End a call	Press and hold the right knob  (In a call)
Adjust call volume	Turn on the knob

Bluetooth Basic Operation

To	Operation (panel)
Previous track	Rotate the knob upwards 
Next track	Rotate the knob downwards 
Playback/Pause	Press 

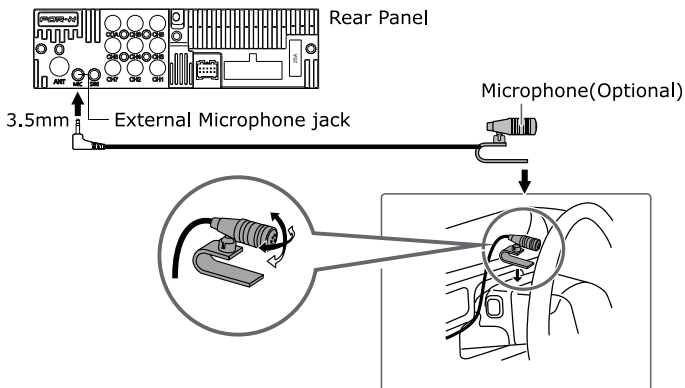
EXTERNAL MICROPHONE:**Note:**

Since the panel microphone is far from the driver' s position, when using an external microphone, you can get better voice calls.

AUDIO SETTINGS:

- 1.Press the knob to enter the [MENU].
- 2.Turn the knob to select [AUDIO], then press the knob.

Audio Settings List

Menu	Adjustment
SW LEVEL	SVOL 0 ~ 8
PRESET EQ	USER/NATURAL/POP/CLASSICAL/ROCK/JAZZ/FLAT/ COUNTRA/ SUPER BASS 28BAND: 25HZ/32HZ/40HZ/50HZ/63HZ/80HZ/100HZ/125HZ/ 160HZ/200HZ/250HZ/310HZ/400HZ/500HZ/630HZ/800HZ/ 1K/1.25K/2K/2.5K/4K/5K/6.3K/8K/10K/12.5K/16K/20K
XBASS	FREQ OFF/60HZ/80HZ/120HZ/160HZ/200HZ/300HZ GAIN 0~3
SURROUND	OFF/ON
BASS	BASS -7 ~ +7
MIDDLE	MIDDLE -7 ~ +7
TREBLE	TREBLE -7 ~ +7
AUDIO RST	NO-YES

Subwoofer Volume Adjustment

- 1.Turn the knob to select [SW LEVEL], then press the knob.
- 2.Turn the knob to adjustment SVOL [-8 to +8].

Preset EQ Select

- 1.Turn the knob to select [PRESET EQ], then press the knob.
- 2.Turn the knob to select [USER/NATURAL/POP/CLASSIC/ROCK/
JAZZ/FLAT/COUNTRA/SUPER BASS].

User EQ Setup

- 1.Turn the knob to select [PRESET EQ], then press the knob.
- 2.Turn the knob to select [USER], then press the knob.
- 3.Turn the knob to select frequency for adjustment.

X-BASS Adjustment

- 1.Turn the knob to select [XBASS], then press the knob.
- 2.Turn the knob to adjustment [0-20].

Surround Setup

- 1.Turn the knob to select [SURROUND], then press the knob.
- 2.Turn the knob to select [OFF/ON].

Bass Adjustment

- 1.Turn the knob to select [BASS], then press the knob.
- 2.Turn the knob to adjustment [-7 to +7].

Middle Adjustment

- 1.Turn the knob to select [MIDDLE], then press the knob.
- 2.Turn the knob to select [L7-LO to R1-R7].

AUDIO SETTINGS:

1. Press the knob to enter the [MENU].
2. Turn the knob to select [AUDIO], then press the knob.

Treble Adjustment

1. Turn the knob to select [TREBLE], then press the knob.
2. Turn the knob to select [-7 to +7].

Audio Setup Reset

1. Turn the knob to select [AUDIO RESET], then press the knob.
2. Turn the knob to select [NO/YES].

XOVER SETUP:

1. Press the knob to enter the [MENU].
2. Turn the knob to select [AUDIO], then long press the knob enter the [XOVER].

Xover List

Menu	Adjustment		
Net 4.2	FRONT	HPF FREQ	FULL/30HZ/40HZ/50HZ/63HZ/70HZ/80HZ/ 90HZ/100HZ/125HZ/160HZ/180HZ/220HZ/ 250HZ/315HZ/400HZ/500HZ/630HZ/700HZ/ 800HZ
		SLOPE	6DB/-12DB/-18DB
		LPF FREQ	FULL/1K/1.6K/2.5K/3.15K/4K/5K/6.3K/ 8K/10K/12.5K
		SLOPE	-6DB/-12DB/-18DB
		PHASE	REVERSE/NORMAL
		GAIN	0 ~ 8
	REAR	HPF FREQ	FULL/30HZ/40HZ/50HZ/63HZ/70HZ/80HZ/ 90HZ/100HZ/125HZ/160HZ/180HZ/220HZ/ 250HZ/315HZ/400HZ/500HZ/630HZ/700HZ/ 800HZ
		SLOPE	-6DB/-12DB/-18DB
		LPF FREQ	FULL/1K/1.6K/2.5K/3.15K/4K/5K/6.3K/ 8K/10K/12.5K
		SLOPE	-6DB/-12DB/-18DB
		PHASE	REVERSE/NORMAL
		GAIN	0 ~ 8
	SUBWOOFER	LPF FREQ	30HZ/40HZ/50HZ/63HZ/70HZ/80HZ/ 90HZ/100HZ/125HZ/160HZ/180HZ/220HZ/ 250HZ/315HZ/400HZ/500HZ/630HZ/700HZ/ 800HZ
		SLOPE	-6DB/-12DB/-18DB
		PHASE	REVERSE/NORMAL
		GAIN	0 ~ 8

XOVER SETUP:

1. Press the knob to enter the [MENU].
2. Turn the knob to select [AUDIO], then long press the knob enter the [XOVER].

Xover List

Menu	Adjustment		
NET 2-WAY	TWEETER	HPF FREQ	FULL/630HZ/700HZ/800HZ/1K/1.6K/ 2.5K/3.15K/4K/5K/6.3K/8K/10K/ 12.5K/
		PHASE	REVERSE/NORMAL
		SLOPE	6DB/12DB/18DB
		GAIN LEFT	0 ~ 8
		GAIN RIGHT	0 ~ 8
	FRONT	HPF FREQ	FULL/30HZ/40HZ/50HZ/63HZ/70HZ/ 80HZ/90HZ/100HZ/125HZ/160HZ/
		SLOPE	-6DB/-12DB/-18DB
		PHASE	REVERSE/NORMAL
		GAIN	0 ~ 8
	REAR	HPF FREQ	FULL/30HZ/40HZ/50HZ/63HZ/70HZ/ 80HZ/90HZ/100HZ/125HZ/160HZ/
		SLOPE	-6DB/-12DB/-18DB
		PHASE	REVERSE/NORMAL
		GAIN	0 ~ 8
	SUBWOOFER	LPF FREQ	30HZ/40HZ/50HZ/63HZ/70HZ/ 80HZ/90HZ/100HZ/125HZ/160HZ/ 180HZ/220HZ/250HZ/315HZ/400HZ/ 500HZ/630HZ/700HZ/800HZ
		SLOPE	-6DB/-12DB/-18DB
		PHASE	REVERSE/NORMAL
GAIN		0 ~ 8	

XOVER SETUP:

1. Press the knob to enter the [MENU].
2. Turn the knob to select [AUDIO], then long press the knob enter the [XOVER].

Xover List

Menu	Adjustment		
NET 3-WAY	TWEETER	HPF FREQ	FULL/630HZ/700HZ/800HZ/1K/1.6K/2.5K/ 3.15K/4K/5K/6.3K/8K/10K/12.5K/
		SLOPE	-6DB/-12DB/-18DB
		PHASE	REVERSE/NORMAL
		GAIN LEFT	0 ~ 8
		GAIN RIGHT	0 ~ 8
	MIDDLE	HPF FREQ	FULL/30HZ/40HZ/50HZ/63HZ/70HZ/80HZ/ 90HZ/100HZ/125HZ/160HZ/180HZ/220HZ/ 250HZ/315HZ/400HZ/500HZ/630HZ/ 700HZ/800HZ
		SLOPE	-6DB/-12DB/-18DB
		LPF FREQ	FULL/630HZ/700HZ/800HZ/1K/1.6K/ 2.5K/3.15K/4K/5K/6.3K/ 8K/10K/12.5K/
		SLOPE	-6DB/-12DB/-18DB
		PHASE	REVERSE/NORMAL
		GAIN	0 ~ 8
	WOOFER	HPF FREQ	FULL/30HZ/40HZ/50HZ/63HZ/70HZ/80HZ/ 90HZ/100HZ/125HZ/160HZ/180HZ/220HZ/ 250HZ/315HZ/400HZ/500HZ/630HZ/ 700HZ/800HZ
		SLOPE	-6DB/-12DB/-18DB
		LPF FREQ	FULL/630HZ/700HZ/800HZ/1K/1.6K/2.5K/ 3.15K/4K/5K/6.3K/8K/10K/12.5K/
		SLOPE	-6DB/-12DB/-18DB
		PHASE	REVERSE/NORMAL
		GAIN	0 ~ 8
	SUBWOOFER	LPF FREQ	30HZ/40HZ/50HZ/63HZ/70HZ/80HZ/90HZ/ 100HZ/125HZ/160HZ/180HZ/220HZ/ 250HZ/315HZ/400HZ/500HZ/630HZ/ 700HZ/800HZ
		SLOPE	-6DB/-12DB/-18DB
		PHASE	REVERSE/NORMAL
GAIN		0 ~ 8	

XOVER SETUP:

1. Press the knob to enter the [MENU].
2. Turn the knob to select [AUDIO], then long press the knob enter the [XOVER].

Net 4.2 Front Setup

1. Turn the knob to select [NET 4.2], then press the knob.
2. Turn the knob to select [FRONT], then press the knob.
3. Turn the knob to select [HPF FREQ/HPF SLOPE/LPF FREQ/LPF SLOPE/ PHASE/ GAIN], then press the knob.

Net 4.2 Rear Setup

1. Turn the knob to select [NET 4.2], then press the knob.
2. Turn the knob to select [FRONT], then press the knob.
3. Turn the knob to select [HPF FREQ/HPF SLOPE/LPF FREQ/LPF SLOPE/ PHASE/ GAIN], then press the knob.

Net 4.2 Subwoofer Setup

1. Turn the knob to select [NET 4.2], then press the knob.
2. Turn the knob to select [SUBWOOFER], then press the knob.
3. Turn the knob to select [LPF FREQ/LPF SLOPE/PHASE/GAIN], then press the knob.

Net 2-Way Tweeter Setup

1. Turn the knob to select [NET 2-WAY], then press the knob.
2. Turn the knob to select [TWEETER], then press the knob.
3. Turn the knob to select [HPF FREQ/GAIN LEFT/GAIN RIGHT], then press the knob.

Net 2-Way Front Setup

1. Turn the knob to select [NET 2-WAY], then press the knob.
2. Turn the knob to select [FRONT], then press the knob.
3. Turn the knob to select [HPF FREQ/HPF SLOPE/GAIN], then press the knob.

Net 2-Way Rear Setup

1. Turn the knob to select [NET 2-WAY], then press the knob.
2. Turn the knob to select [REAR], then press the knob.
3. Turn the knob to select [HPF FREQ/HPF SLOPE/GAIN], then press the knob.

Net 2-Way Subwoofer Setup

1. Turn the knob to select [NET 2-WAY], then press the knob.
2. Turn the knob to select [SUBWOOFER], then press the knob.
3. Turn the knob to select [LPF FREQ/LPF SLOPE/LPF PHASE/GAIN], then press the knob.

XOVER SETUP:

1. Press the knob to enter the [MENU].
2. Turn the knob to select [AUDIO], then long press the knob enter the [XOVER].

Net 3-Way Tweeter Setup

1. Turn the knob to select [NET 3-WAY], then press the knob.
2. Turn the knob to select [TWEETER], then press the knob.
3. Turn the knob to select [HPF FREQ/HPF SLOPE/PHASE/GAIN LEFT/ GAIN RIGHT], then press the knob.

Net 3-Way Middle Setup

1. Turn the knob to select [NET 3-WAY], then press the knob.
2. Turn the knob to select [MIDDLE], then press the knob.
3. Turn the knob to select [HPF FREQ/HPF SLOPE/LPF FREQ/LPF SLOPE/ PHASE/GAIN], then press the knob.

Net 3-Way Woofer Setup

1. Turn the knob to select [NET 3-WAY], then press the knob.
2. Turn the knob to select [WOOFER], then press the knob.
3. Turn the knob to select [HPF FREQ/HPF SLOPE/LPF FREQ/LPF SLOPE/ PHASE/GAIN], then press the knob.

Net 3-Way Subwoofer Setup

1. Turn the knob to select [NET 3-WAY], then press the knob.
2. Turn the knob to select [SUBWOOFER], then press the knob.
3. Turn the knob to select [LPF FREQ/LPF SLOPE/PHASE/GAIN], then press the knob.

ANIMATION SETTINGS:

1. Press the knob to enter the [MENU].
2. Turn the knob to select [ANIMATION], then press the knob.
3. Turn the knob to select [OFF/PER 15SEC/30SEC/1MIN/2MIN/4MIN].

Menu	Adjustment
ANIMATION	OFF/PER 15SEC/30SEC/1MIN/2MIN/4MIN

DEMO MODE SELECT:

1. Press the knob to enter the [MENU].
2. Turn the knob to select [DEMO MODE], then press the knob.
3. Turn the knob to select [OFF/ON].

Menu	Adjustment
DEMO MODE	OFF/ON

DTA SETTINGS:

- 1.Press the knob to enter the [MENU].
- 2.Turn the knob to select [DTA SET], then press the knob.

DTA Settings List

Menu	Adjustment	
CAR TYPE	SMALL/MEDIUM /LARGE	
POSITION	USER/FRONT L/FRONT R/CENTER	
UNIT	MS/CM/INCH	
DISTANCE (NET 4.2)	CH1 FL	0~18.0MS/ 0~612CM/ 0~240 INCH
	CH2 FR	0~18.0MS/ 0~612CM/ 0~240 INCH
	CH3 RL	0~18.0MS/ 0~612CM/ 0~240 INCH
	CH4 RR	0~18.0MS/ 0~612CM/ 0~240 INCH
	CH5	0~18.0MS/ 0~612CM/ 0~240 INCH
	CH6	0~18.0MS/ 0~612CM/ 0~240 INCH
	CH8 SUB	0~18.0MS/ 0~612CM/ 0~240 INCH
DISTANCE (NET 2-WAY)	CH1 FL-TW	0~18.0MS/ 0~612CM/ 0~240 INCH
	CH2 FR-TW	0~18.0MS/ 0~612CM/ 0~240 INCH
	CH3 FL-WF	0~18.0MS/ 0~612CM/ 0~240 INCH
	CH4 FR-WF	0~18.0MS/ 0~612CM/ 0~240 INCH
	CH5 RL	0~18.0MS/ 0~612CM/ 0~240 INCH
	CH6 RR	0~18.0MS/ 0~612CM/ 0~240 INCH
	CH8 SUB	0~18.0MS/ 0~612CM/ 0~240 INCH
DISTANCE (NET 3-WAY)	CH1 FL-TW	0~18.0MS/ 0~612CM/ 0~240 INCH
	CH2 FR-TW	0~18.0MS/ 0~612CM/ 0~240 INCH
	CH3 FL-MD	0~18.0MS/ 0~612CM/ 0~240 INCH
	CH4 FR-MD	0~18.0MS/ 0~612CM/ 0~240 INCH
	CH5 FL-WF	0~18.0MS/ 0~612CM/ 0~240 INCH
	CH6 FR-WF	0~18.0MS/ 0~612CM/ 0~240 INCH
	CH8 SUB	0~18.0MS/ 0~612CM/ 0~240 INCH
DIA RST	NO/YES	

DTA SETTINGS:

- 1.Press the knob to enter the [MENU].
- 2.Turn the knob to select [DTA SET], then press the knob.

Car Type Settings

- 1.Turn the knob to select [CAR TYPE], then press the knob.
- 2.Turn the knob to select [SMALL /MEDIUM /LARGE].

Listening Position Settings

- 1.Turn the knob to select [POSITION], then press the knob.
- 2.Turn the knob to select [USER/FRONT R/FRONT L/CENTER].

Delay Unit Settings

- 1.Turn the knob to select [UNIT], then press the knob.
- 2.Turn the knob to select [MS/CM/INCH].

Distance Net 4.2 Settings

- 1.Turn the knob to select [DISTANCE], then press the knob.
- 2.Turn the knob to select [CH1~CH8], then press the knob.
- 3.Turn the knob to select[0~18.0MS/ 0~612CM/ 0~240 INCH].

Distance Net 2-Way Settings

- 1.Turn the knob to select [DISTANCE], then press the knob.
- 2.Turn the knob to select [CH1~CH8], then press the knob.
- 3.Turn the knob to select[0~18.0MS/ 0~612CM/0~240 INCH].

Distance Net 3-Way Settings

- 1.Turn the knob to select [DISTANCE], then press the knob.
- 2.Turn the knob to select [CH1~CH8], then press the knob.
- 3.Turn the knob to select[0~18.0MS/ 0~612CM/ 0~240 INCH].

Note: Net 4.2/Net 2-Way /Net 3-Way can be set in the "XOVER" option.

DTA Reset

- 1.Turn the knob to select [DTA RST], then press the knob.
- 2.Turn the knob to select [NO/YES].

TIME ALIGNMENT(DISTANCE):

- 1.Press the knob to enter the [MENU].
- 2.Turn the knob to select [DTA SET], then press the knob.
- 3.Turn the knob to select [DISTANCE], then press the knob.
- 4.Turn the knob to select[F LEFT/F RIGHT/R LEFT/R RIGHT/SUBWOOFER] to adjustment.

Determining the value for<Position> adjustment.

- ① Determine the center of the currently set listening position as the reference point.
- ② The adjustable speaker has five directions: front left, front right, back left, back right, and back.
- ③ The time for the speakers in the five directions to reach the center is the same by default.
- ④ Set the value for each speaker, the delay range: 0-20ms.
- ⑤ Adjust the increase or decrease of each speaker, 0.2ms each time.

Example: When <back> is selected as the listening position:

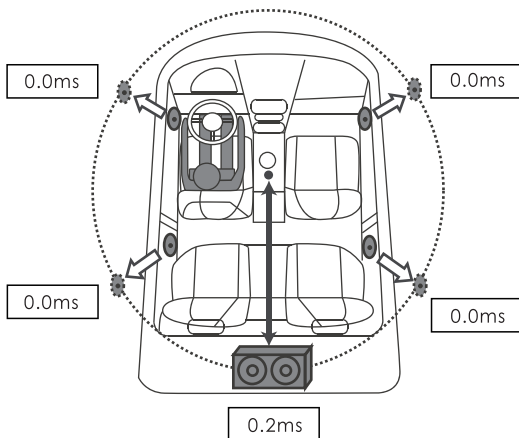

CLOCK AND DATE SETTINGS:

1. Press the knob to enter the [MENU].
2. Turn the knob to select [CLOCK], then press the knob.

Clock And Date Settings List

Menu	Adjustment
CLK FORMAT	12H/24H
CLK ADJ	00:00
DATE FRMT	DD-MM-YY/MM-DD-YY
DATE SET	01/01/23

Clock Format Settings

1. Turn the knob to select [CLK FORMAT], then press the knob.
2. Turn the knob to select [12H/24H].

Clock Adjust

1. Turn the knob to select [CLK ADJ], then press the knob.
2. Turn the knob to adjustment.
3. Press the knob to switch the clock/minute adjustment.

Date Format Settings

1. Turn the knob to select [DATE FORMAT], then press the knob.
2. Turn the knob to select [DD-MM-YY/MM-DD-YY].

Date Settings

1. Turn the knob to select [DATE SET], then press the knob.
2. Turn the knob to adjustment.
3. Press the knob to switch day/month/year adjustment.

TUNER SETTINGS:

1. Press the knob to enter the [MENU].
2. Turn the knob to select [TUNER], then press the knob.

Tuner Settings List

Menu	Adjustment	
TUNER	MONO/STEREO	NEWS/AFFAIRS/INFO/SPORT
	DX/LOCAL	EDUCATE/DRAMA/CULTURE
	RDS OFF/ON	SCIENCE/VARIED/POP M/ ROCK M/EASY M/LIGHT M/ CLASSICS/OTHER M/WEATHER/ FINANCE/CHILDREN/SOCIAL/ RELIGION /PHONE IN/TRAVEL/ LEISURE/JAZZ/COUNTRY/ NATION M/OLDIES/FOLK M/ DOCUMENT
	TA OFF/ON	
	AF ON/OFF	
	EON OFF/ON	
	REG OFF/ON	
	PTY OFF/ON	
	REGIONAL EUROPE/USA/ASIA/RUSSIA	

TUNER SETTINGS:

Stereo/Mono Select

Turn the knob to select [STEREO or MONO], then turn the knob select [STEREO/MONO].

DX/Local Select

Turn the knob to select [LOC or DX], then turn the knob select [DX /LOCAL].
Remark: DX:Distant exchange.

RDS ON/OFF

Turn the knob to select [RDS OFF], then turn the knob select [RDS OFF, ON].

Tuner Area Select

Turn the knob to select [REGIONAL], then turn the knob select [ASIA/RUSSIA/EUR/USA].

DISPLAY SETTINGS:

- 1.Press the knob to enter the [MENU].
- 2.Turn the knob to select [DISPLAY], then press the knob.

Display Settings List

Menu	Adjustment
MODE SEL	C-MODE1/C-MODE2/MODE3/
COLOR	AUTO/RED/GREEN/BLUE/YELLOW/ CYAN/PURPLE/WHITE
SPECTRUM	C-MODE1
ID3 TAG	OFF/ON

Key Light Select

- 1.Turn the knob to select [COLOR SEL], then press the knob.
- 2.Turn the knob to select key light color:[AUTO/RED/GREEN /BLUE/YELLOW/CYAN/PURPLE/WHITE].

Spectrum ON/OFF

- 1.Turn the knob to select [SPECTRUM], then press the knob.
- 2.Turn the knob to select [OFF/ON].

ID3 ON/OFF

- 1.Turn the knob to select [ID3 TAG], then press the knob.
- 2.Turn the knob to select [OFF/ON].

System Version

Turn the knob to select [VERSION], then press the button to query the system version information.

TROUBLE SHOOTING:

Not work

Fuse blown
Loose panel contact

Remedy

Replace the fuse: small 25A(white)
Take out the panel and reinstall

Not responding

System problem

Reset the unit

No bass

Subwoofer setting level
is too small

Enter AUDIO to set SVOL

Can't turn on voice

Bluetooth is not connected
Phone does not support voice

Connect Bluetooth
N.A

Not playing

Incorrect device format
Device error
Unsupported audio file

Reformat
Replacement device
Replace supported audio files

Radio reception is poor

Poor contact of radio antenna
Poor signal at location

Reconnect the radio antenna
Change to other positions

Remote control is invalid

Remote control battery is low

Replace CR2025 battery

Bluetooth call is poor

Microphone is too far away

Speak into the microphone

SPEAKER CONNECTION:

Do not connect the speaker leads of the power cord to the car battery; otherwise, the unit will be seriously damaged.

Before oconnecting the speak leads of the power cord to the speakers, check the speaker wiring in your car.

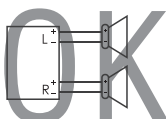
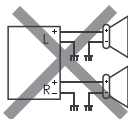
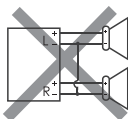

SPECIFICATION:

GENERAL	Operating Voltage	14.4V(10.8V allowable)
	Maximum Current	25A
	Operational Temperature	-10°~+60°
	Installation Size(WxHxD)	182mmx53mmx115mm
	Net Weight	0.6kg
	Fuse	Small fuse 25A (white)

AUDIO	Maximum Output Power	100Wx4
	Speaker Impedance	4-8ohm
	Pre-output Level	4v

RADIO	FM Frequency Range	87.5MHz-108.0MHz
	AM Frequency Range	522KHz-1710KHz
	Preset	18FM, 12AM

USB	USB Standard	USB1.1, USB2.0 Full Speed
	Audio Format	MP3/WMA/APE/FLAC/ AAC/M4A/WAV
	USB	Charge DC 5V=2A

BLUETOOTH	Version	Bluetooth 5.0
	Frequency Range	2.402GHz-2.480GHz
	Communication Range	Line of sight approx.10m
	Profile	HPF1.6/A2DP/AVR/SPP