

FOR-X

www.for-x.com.tr

Owner's Manuel

XQ-7450DSP DIGITAL MEDIA RECEIVER



App Store



Google Play

CE

CONTENTS:

| | |
|-------------------------------------|----|
| Warnings&Precautions | 01 |
| Product Features | 01 |
| Installation | 02 |
| Accessory List | 03 |
| Dimension(Unit:mm) | 03 |
| Wiring Diagram | 04 |
| Basic Functions Of Panel Keys | 05 |
| Remote Operation | 06 |
| APP Operation | 06 |
| Radio Operation | 07 |
| USB&SD Playback | 07 |
| Bluetooth Operation | 08 |
| AUX Input | 09 |
| External Microphone | 09 |
| Audio Settings | 10 |
| Xover Setup | 11 |
| Animation Settings | 15 |
| Demo Mode Select | 15 |
| DTA Setup | 16 |
| Time Alignment(Distance) | 18 |
| Clock And Date Settings | 19 |
| Tuner Settings | 19 |
| Display Settings | 20 |
| Trouble Shooting | 21 |
| Speaker Connection | 21 |
| Specification | 22 |

WARNINGS & PRECAUTIONS:

To avoid risk of serious injury or possible violation of laws, please read the following thoroughly before installation or connecting.

- This product is designed specifically for use with 12 volt, negative ground electrical systems only.
- Having the wiring and installation done by expert.
Be sure to disconnect the cable from the negative battery terminal while installtion.
- This apparatus shall not be exposed to dripping or splashing, and no object filled with liquids shall be placed on the apparatus.
- Fuses shall be replaced only with the correct type and fuse value, and only when the apparatus is powered off.
- To prevent a short circuit, never put or leave any metallic objects(such as coins or metallic tools)inside the unit.
- Never set the volume of this product so high that you cannot hear outside traffic and emergency vehicles.

PRODUCT FEATURES:

Panel: Fixed

LCD:VA-LCD

Key Light: Multi Color

Bluetooth: Version 5.0

Bluetooth Music: Support

DSP: Built-in

EQ: 28 Band,8 Preset

Pre-Output: 8CH x 4V

Max Power: 4 x 100W

Xbass: Support

Xover: Support

3D Surround: Support

2-Way Network: Support

3-Way Network: Support

Time Alignmnet: 0-18 ms

Q Value: 1-20

Subwoofer Control: Support

Playback Interface: TF & USB

Phase: 0°-180°

Listening Bit Setting: Support

Slope: Support

PAC™-SWI: Support

Remote: Support

Microphone: Built-in and External

Radio: Preset 18FM, 12AM, RDS

APP Control: iOS and Android Phone

Charge: Rear USB 2A

Audio Format: MP3, WMA, AAC, FLAC, APE

INSTALLATION

Installation Procedures

First complete the electrical connections and then check for correctness.

Installation Opening

This unit can be installed in any dashboard Having an opening as shown below:

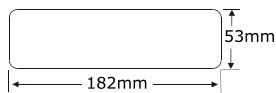

TO Install The Car Radio

Be sure you test all connections first, and then follow these steps to install this unit.

1. Make sure the ignition is turned off, and then disconnect the cable from the vehicle battery's negative (-) terminal.
2. Disconnect the wire harness and the antenna.
3. Remove the detachable panel and decorative enclosure frame and place on one side.
4. Insert the two brackets into the left and right sides of the chassis, as shown in the following figure, and separate the chassis from the sleeve.

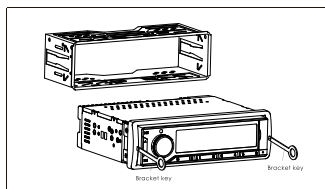

5. Insert the installation sleeve into the center console to be installed, and bend the clip using a screwdriver. Make sure the locking rod is flush with the mounting sleeve and does not protrude.
6. Connect cables as shown in the Wiring diagram.
7. Insert the car radio into the mounting sleeve.
8. Install decorative enclosure frame.

ACCESSORY LIST:

Please check the following accessories after opening the package:

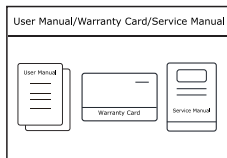
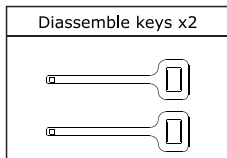
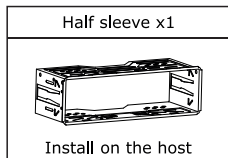
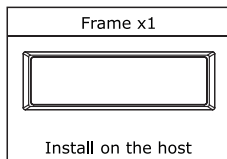
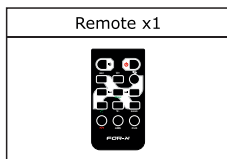
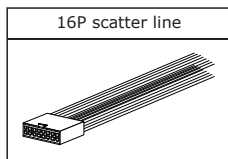

DIMENSION(UNIT:MM):

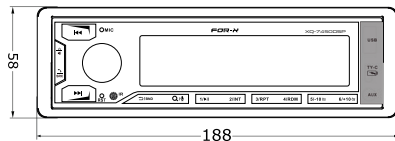
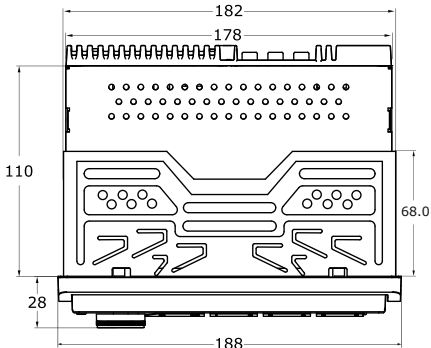
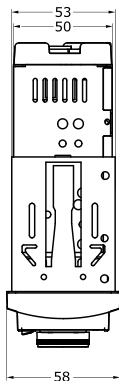

WIRING DIAGRAM:

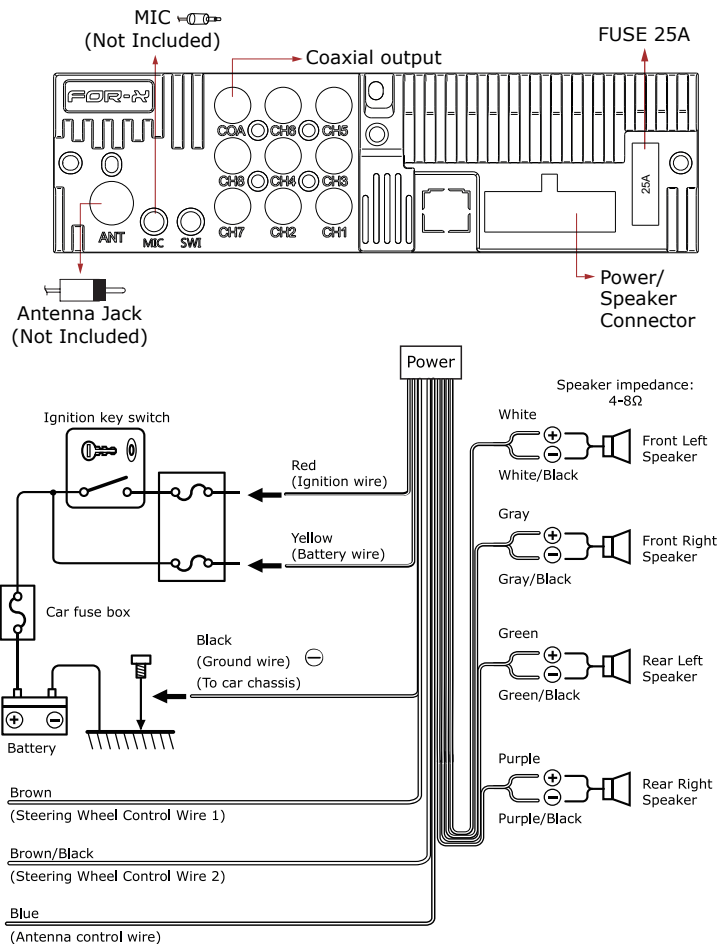

BASIC FUNCTIONS OF PANEL KEYS:

| To | Radio status | USB/TF/BT MUSIC Status |
|-------|--|------------------------|
| ⏮ ⏭ | Seek a station manually | Previous/Next track |
| 1 ▶/ | Preset 1 | Playback/Pause |
| INT 2 | Preset 2 | Intro Playback |
| 3 RPT | Preset 3 | Repeat Playback |
| RDM 4 | Preset 4 | Random Playback |
| 5 6 | Preset 5/Preset 6 | Previous/Next folder |
| ↶/BND | Band select/Return | |
| ⏻ 🔊 | Press to mute, Press and hold to power off | |
| 🗣 🔍 | Press to turn on voice, Press an hold to auto memory | |
| ↶/SRC | Source selection/Answer call Press an hold to last call | |

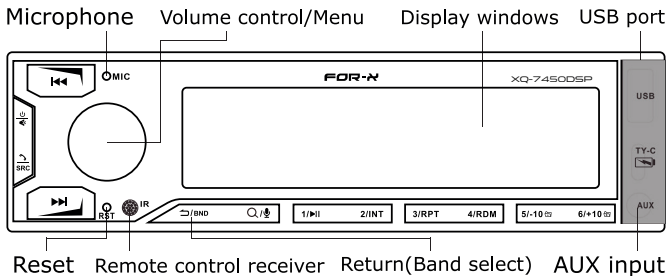

REMOTE OPERATION:

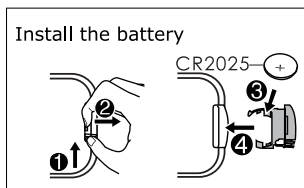
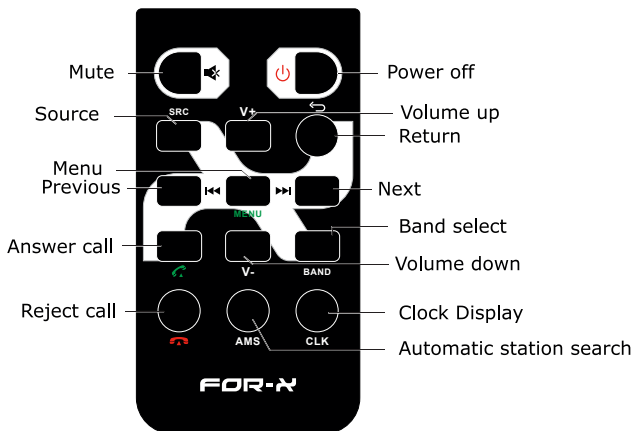

APP OPERATION:

APP Download

Method 1: Please scan the QR code on the cover to download the APP and install it on your Android or Apple device.

Method 2: Please go to the APPLE APP Store or Google Play Store and search [AUDIO DSP Control] APP, after downloading the APP, install it on your Appale&Android devices.

APP Connection

1. Open the [AUDIO DSP Control] APP, click [🔍] to search for XQ-7450DSP
2. Click XQ-7450DSP to connect, the [📶] will be red after the connect is successful.

RADIO OPERATION:

Start Listening

| To | Operation (panel) | Remark |
|--|--------------------------|---------------------|
| Auto memory | Press and hold Q | 18 FM/12AM |
| Band selection | Press ↔/BND | FM1/FM2/FM3/AM1/AM2 |
| Seek a station manually | Press ◀▶ | |
| Search the next or previous frequency step by step | Press and hold ◀▶ | |
| Store a station | Press and hold 1-6 | |

| RADIO | |
|--------------------|--|
| FM Frequency Range | Europe Area: 87.5 ~ 108.0 KHz (50KHz / Step) |
| | U.S.A.Area: 87.5~107.9 KHz (200 KHz / Step) |
| | ASIA Area: 87.5~108.0 KHz (100 KHz / Step) |
| | RUSS Area: 65.0 ~74.0 KHz (30 KHz/ Step) |
| Preset | 18FM / 12AM |

USB&SD PLAYBACK:

| To | Operation (panel) |
|------------------|--|
| Track selection | Press ◀▶ |
| Fast playback | Press and hold ◀▶ |
| Playback/Pause | Press 1/ |
| Track pre-play | Press INT 2 |
| Repeat playback | Press 3 RPT ● REPEAT ONE.REPEAT DIR.REPEAT ALL |
| Random playback | Press RDM 4 ● ON/OFF |
| Folder selection | Press 5 ☰ 6 |

BLUETOOTH OPERATION:

Bluetooth Pairing

The first time pair mobile phone with receiver, please follow below steps:

1. When there is no pairing, in any mode, the BT on the LCD will flash, and the pairing can be performed at this time.
2. Turn on the phone's Bluetooth to Search XQ-7450DSP
3. Click on the XQ-7450DSP on the phone to connect. After the connection is successful, the BT will stop flashing.
4. When pairing is complete, the mobile phone audio will automatically transfer to the car audio system whenever a call is made or received, or when the mobile phone plays music.

Note:

For more details of bluetooth pairing, please refer to the owner's manual for your mobile phone.

Bluetooth Basic Operation

| To | Operation (panel) |
|--|---------------------------------------|
| Make a call | Bluetooth mobile phone connected |
| Answer a call | Press \sim /SRC |
| Reject an incoming call | Press an hold \sim /SRC |
| Switch between the current caller and a caller on hold | Press \sim /SRC (In a call) |
| End a call | Press an hold \sim /SRC (In a call) |
| Adjust call volume | Turn on the knob |

Bluetooth Basic Operation

| To | Operation (panel) |
|----------------|---------------------|
| Previous track | Press \lll |
| Next track | Press \ggg |
| Playback/Pause | Press $1/\text{ }$ |

AUX INPUT:

1.Connect a portable audio player(commmercially available).

Auxiliary input jack

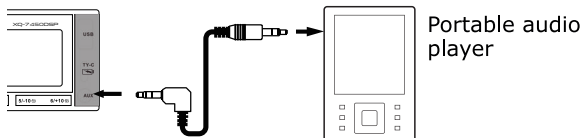

Auxiliary input jack

3.5mm stereo mini plug with "L" shaped connector.
(commercially available).

2.Press[\curvearrowright /SRC]buttons to select AUX IN.

3.Turn on the portable audio player and start playback.

EXTERNAL MICROPHONE:

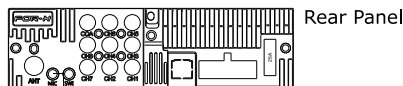

3.5mm External Microphone jack

Microphone(Optional)

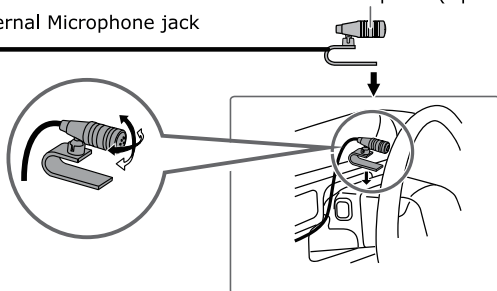

Note:

Since the panel microphone is far from the driver' s position,
when using an external microphone, you can get better voice calls.

AUDIO SETTINGS:

- 1.Press the knob to enter the [MENU].
- 2.Turn the knob to select [AUDIO], then press the knob.

Audio Settings List

| Menu | Adjustment |
|-----------|---|
| SW LEVEL | SVOL 0 ~ 8 |
| PRESET EQ | USER/NATURAL/POP/CLASSICAL/ROCK/JAZZ/FLAT/ COUNTRA/ SUPER BASS 28BAND: 25HZ/32HZ/40HZ/50HZ/63HZ/80HZ/100HZ/125HZ/ 160HZ/200HZ/250HZ/310HZ/400HZ/500HZ/630HZ/800HZ/ 1K/1.25K/2K/2.5K/4K/5K/6.3K/8K/10K/12.5K/16K/20K |
| XBASS | FREQ OFF/60HZ/80HZ/120HZ/160HZ/200HZ/300HZ GAIN 0~3 |
| SURROUND | OFF/ON |
| BASS | BASS -7 ~ +7 |
| MIDDLE | MIDDLE -7 ~ +7 |
| TREBLE | TREBLE -7 ~ +7 |
| AUDIO RST | NO-YES |

Subwoofer Volume Adjustment

- 1.Turn the knob to select [SW LEVEL], then press the knob.
- 2.Turn the knob to adjustment SVOL [-8 to +8].

Preset EQ Select

- 1.Turn the knob to select [PRESET EQ], then press the knob.
- 2.Turn the knob to select [USER/NATURAL/POP/CLASSIC/ROCK/
JAZZ/FLAT/COUNTRA/SUPER BASS].

User EQ Setup

- 1.Turn the knob to select [PRESET EQ], then press the knob.
- 2.Turn the knob to select [USER], then press the knob.
- 3.Turn the knob to select frequency for adjustment.

X-BASS Adjustment

- 1.Turn the knob to select [XBASS], then press the knob.
- 2.Turn the knob to adjustment [0-20].

Surround Setup

- 1.Turn the knob to select [SURROUND], then press the knob.
- 2.Turn the knob to select [OFF/ON].

Bass Adjustment

- 1.Turn the knob to select [BASS], then press the knob.
- 2.Turn the knob to adjustment [-7 to +7].

Middle Adjustment

- 1.Turn the knob to select [MIDDLE], then press the knob.
- 2.Turn the knob to select [L7-LO to R1-R7].

AUDIO SETTINGS:

- 1.Press the knob to enter the [MENU].
- 2.Turn the knob to select [AUDIO], then press the knob.

Treble Adjustment

- 1.Turn the knob to select [TREBLE], then press the knob.
- 2.Turn the knob to select [-7 to +7].

Audio Setup Reset

- 1.Turn the knob to select [AUDIO RESET], then press the knob.
- 2.Turn the knob to select [NO/YES].

XOVER SETUP:

- 1.Press the knob to enter the [MENU].
- 2.Turn the knob to select [AUDIO], then long press the knob enter the [XOVER].

Xover List

| Menu | Adjustment | | |
|---------|------------|----------|---|
| Net 4.2 | FRONT | HPF FREQ | FULL/30HZ/40HZ/50HZ/63HZ/70HZ/80HZ/ 90HZ/100HZ/125HZ/160HZ/180HZ/220HZ/ 250HZ/315HZ/400HZ/500HZ/630HZ/700HZ/ 800HZ |
| | | SLOPE | 6DB/-12DB/-18DB |
| | | LPF FREQ | FULL/1K/1.6K/2.5K/3.15K/4K/5K/6.3K/ 8K/10K/12.5K |
| | | SLOPE | -6DB/-12DB/-18DB |
| | | PHASE | REVERSE/NORMAL |
| | | GAIN | 0 ~ 8 |
| | REAR | HPF FREQ | FULL/30HZ/40HZ/50HZ/63HZ/70HZ/80HZ/ 90HZ/100HZ/125HZ/160HZ/180HZ/220HZ/ 250HZ/315HZ/400HZ/500HZ/630HZ/700HZ/ 800HZ |
| | | SLOPE | -6DB/-12DB/-18DB |
| | | LPF FREQ | FULL/1K/1.6K/2.5K/3.15K/4K/5K/6.3K/ 8K/10K/12.5K |
| | | SLOPE | -6DB/-12DB/-18DB |
| | | PHASE | REVERSE/NORMAL |
| | | GAIN | 0 ~ 8 |
| | SUBWOOFER | LPF FREQ | 30HZ/40HZ/50HZ/63HZ/70HZ/80HZ/ 90HZ/100HZ/125HZ/160HZ/180HZ/220HZ/ 250HZ/315HZ/400HZ/500HZ/630HZ/700HZ/ 800HZ |
| | | SLOPE | -6DB/-12DB/-18DB |
| | | PHASE | REVERSE/NORMAL |
| | | GAIN | 0 ~ 8 |

XOVER SETUP:

1. Press the knob to enter the [MENU].
2. Turn the knob to select [AUDIO], then long press the knob enter the [XOVER].

Xover List

| Menu | Adjustment | | |
|-----------|------------|------------|--|
| NET 2-WAY | TWEETER | HPF FREQ | FULL/630HZ/700HZ/800HZ/1K/1.6K/ 2.5K/3.15K/4K/5K/6.3K/8K/10K/ 12.5K/ |
| | | PHASE | REVERSE/NORMAL |
| | | SLOPE | 6DB/12DB/18DB |
| | | GAIN LEFT | 0 ~ 8 |
| | | GAIN RIGHT | 0 ~ 8 |
| | FRONT | HPF FREQ | FULL/30HZ/40HZ/50HZ/63HZ/70HZ/ 80HZ/90HZ/100HZ/125HZ/160HZ/ |
| | | SLOPE | -6DB/-12DB/-18DB |
| | | PHASE | REVERSE/NORMAL |
| | | GAIN | 0 ~ 8 |
| | REAR | HPF FREQ | FULL/30HZ/40HZ/50HZ/63HZ/70HZ/ 80HZ/90HZ/100HZ/125HZ/160HZ/ |
| | | SLOPE | -6DB/-12DB/-18DB |
| | | PHASE | REVERSE/NORMAL |
| | | GAIN | 0 ~ 8 |
| | SUBWOOFER | LPF FREQ | 30HZ/40HZ/50HZ/63HZ/70HZ/ 80HZ/90HZ/100HZ/125HZ/160HZ/ 180HZ/220HZ/250HZ/315HZ/400HZ/ 500HZ/630HZ/700HZ/800HZ |
| | | SLOPE | -6DB/-12DB/-18DB |
| | | PHASE | REVERSE/NORMAL |
| GAIN | | 0 ~ 8 | |

XOVER SETUP:

1. Press the knob to enter the [MENU].
2. Turn the knob to select [AUDIO], then long press the knob enter the [XOVER].

Xover List

| Menu | Adjustment | | |
|-----------|------------|------------|---|
| NET 3-WAY | TWEETER | HPF FREQ | FULL/630HZ/700HZ/800HZ/1K/1.6K/2.5K/ 3.15K/4K/5K/6.3K/8K/10K/12.5K/ |
| | | SLOPE | -6DB/-12DB/-18DB |
| | | PHASE | REVERSE/NORMAL |
| | | GAIN LEFT | 0 ~ 8 |
| | | GAIN RIGHT | 0 ~ 8 |
| | MIDDLE | HPF FREQ | FULL/30HZ/40HZ/50HZ/63HZ/70HZ/80HZ/ 90HZ/100HZ/125HZ/160HZ/180HZ/220HZ/ 250HZ/315HZ/400HZ/500HZ/630HZ/ 700HZ/800HZ |
| | | SLOPE | -6DB/-12DB/-18DB |
| | | LPF FREQ | FULL/630HZ/700HZ/800HZ/1K/1.6K/ 2.5K/3.15K/4K/5K/6.3K/ 8K/10K/12.5K/ |
| | | SLOPE | -6DB/-12DB/-18DB |
| | | PHASE | REVERSE/NORMAL |
| | | GAIN | 0 ~ 8 |
| | WOOFER | HPF FREQ | FULL/30HZ/40HZ/50HZ/63HZ/70HZ/80HZ/ 90HZ/100HZ/125HZ/160HZ/180HZ/220HZ/ 250HZ/315HZ/400HZ/500HZ/630HZ/ 700HZ/800HZ |
| | | SLOPE | -6DB/-12DB/-18DB |
| | | LPF FREQ | FULL/630HZ/700HZ/800HZ/1K/1.6K/2.5K/ 3.15K/4K/5K/6.3K/8K/10K/12.5K/ |
| | | SLOPE | -6DB/-12DB/-18DB |
| | | PHASE | REVERSE/NORMAL |
| | | GAIN | 0 ~ 8 |
| | SUBWOOFER | LPF FREQ | 30HZ/40HZ/50HZ/63HZ/70HZ/80HZ/90HZ/ 100HZ/125HZ/160HZ/180HZ/220HZ/ 250HZ/315HZ/400HZ/500HZ/630HZ/ 700HZ/800HZ |
| | | SLOPE | -6DB/-12DB/-18DB |
| | | PHASE | REVERSE/NORMAL |
| GAIN | | 0 ~ 8 | |

XOVER SETUP:

1. Press the knob to enter the [MENU].
2. Turn the knob to select [AUDIO], then long press the knob enter the [XOVER].

Net 4.2 Front Setup

1. Turn the knob to select [NET 4.2], then press the knob.
2. Turn the knob to select [FRONT], then press the knob.
3. Turn the knob to select [HPF FREQ/HPF SLOPE/LPF FREQ/LPF SLOPE/ PHASE/ GAIN], then press the knob.

Net 4.2 Rear Setup

1. Turn the knob to select [NET 4.2], then press the knob.
2. Turn the knob to select [FRONT], then press the knob.
3. Turn the knob to select [HPF FREQ/HPF SLOPE/LPF FREQ/LPF SLOPE/ PHASE/ GAIN], then press the knob.

Net 4.2 Subwoofer Setup

1. Turn the knob to select [NET 4.2], then press the knob.
2. Turn the knob to select [SUBWOOFER], then press the knob.
3. Turn the knob to select [LPF FREQ/LPF SLOPE/PHASE/GAIN], then press the knob.

Net 2-Way Tweeter Setup

1. Turn the knob to select [NET 2-WAY], then press the knob.
2. Turn the knob to select [TWEETER], then press the knob.
3. Turn the knob to select [HPF FREQ/GAIN LEFT/GAIN RIGHT], then press the knob.

Net 2-Way Front Setup

1. Turn the knob to select [NET 2-WAY], then press the knob.
2. Turn the knob to select [FRONT], then press the knob.
3. Turn the knob to select [HPF FREQ/HPF SLOPE/GAIN], then press the knob.

Net 2-Way Rear Setup

1. Turn the knob to select [NET 2-WAY], then press the knob.
2. Turn the knob to select [REAR], then press the knob.
3. Turn the knob to select [HPF FREQ/HPF SLOPE/GAIN], then press the knob.

Net 2-Way Subwoofer Setup

1. Turn the knob to select [NET 2-WAY], then press the knob.
2. Turn the knob to select [SUBWOOFER], then press the knob.
3. Turn the knob to select [LPF FREQ/LPF SLOPE/LPF PHASE/GAIN], then press the knob.

XOVER SETUP:

1. Press the knob to enter the [MENU].
2. Turn the knob to select [AUDIO], then long press the knob enter the [XOVER].

Net 3-Way Tweeter Setup

1. Turn the knob to select [NET 3-WAY], then press the knob.
2. Turn the knob to select [TWEETER], then press the knob.
3. Turn the knob to select [HPF FREQ/HPF SLOPE/PHASE/GAIN LEFT/ GAIN RIGHT], then press the knob.

Net 3-Way Middle Setup

1. Turn the knob to select [NET 3-WAY], then press the knob.
2. Turn the knob to select [MIDDLE], then press the knob.
3. Turn the knob to select [HPF FREQ/HPF SLOPE/LPF FREQ/LPF SLOPE/ PHASE/GAIN], then press the knob.

Net 3-Way Woofer Setup

1. Turn the knob to select [NET 3-WAY], then press the knob.
2. Turn the knob to select [WOOFER], then press the knob.
3. Turn the knob to select [HPF FREQ/HPF SLOPE/LPF FREQ/LPF SLOPE/ PHASE/GAIN], then press the knob.

Net 3-Way Subwoofer Setup

1. Turn the knob to select [NET 3-WAY], then press the knob.
2. Turn the knob to select [SUBWOOFER], then press the knob.
3. Turn the knob to select [LPF FREQ/LPF SLOPE/PHASE/GAIN], then press the knob.

ANIMATION SETTINGS:

1. Press the knob to enter the [MENU].
2. Turn the knob to select [ANIMATION], then press the knob.
3. Turn the knob to select [OFF/PER 15SEC/30SEC/1MIN/2MIN/4MIN].

| Menu | Adjustment |
|-----------|------------------------------------|
| ANIMATION | OFF/PER 15SEC/30SEC/1MIN/2MIN/4MIN |

DEMO MODE SELECT:

1. Press the knob to enter the [MENU].
2. Turn the knob to select [DEMO MODE], then press the knob.
3. Turn the knob to select [OFF/ON].

| Menu | Adjustment |
|-----------|------------|
| DEMO MODE | OFF/ON |

DTA SETTINGS:

- 1.Press the knob to enter the [MENU].
- 2.Turn the knob to select [DTA SET], then press the knob.

DTA Settings List

| Menu | Adjustment | |
|-------------------------|-----------------------------|-------------------------------|
| CAR TYPE | SMALL/MEDIUM /LARGE | |
| POSITION | USER/FRONT L/FRONT R/CENTER | |
| UNIT | MS/CM/INCH | |
| DISTANCE (NET 4.2) | CH1 FL | 0~18.0MS/ 0~612CM/ 0~240 INCH |
| | CH2 FR | 0~18.0MS/ 0~612CM/ 0~240 INCH |
| | CH3 RL | 0~18.0MS/ 0~612CM/ 0~240 INCH |
| | CH4 RR | 0~18.0MS/ 0~612CM/ 0~240 INCH |
| | CH5 | 0~18.0MS/ 0~612CM/ 0~240 INCH |
| | CH6 | 0~18.0MS/ 0~612CM/ 0~240 INCH |
| | CH8 SUB | 0~18.0MS/ 0~612CM/ 0~240 INCH |
| DISTANCE (NET 2-WAY) | CH1 FL-TW | 0~18.0MS/ 0~612CM/ 0~240 INCH |
| | CH2 FR-TW | 0~18.0MS/ 0~612CM/ 0~240 INCH |
| | CH3 FL-WF | 0~18.0MS/ 0~612CM/ 0~240 INCH |
| | CH4 FR-WF | 0~18.0MS/ 0~612CM/ 0~240 INCH |
| | CH5 RL | 0~18.0MS/ 0~612CM/ 0~240 INCH |
| | CH6 RR | 0~18.0MS/ 0~612CM/ 0~240 INCH |
| | CH8 SUB | 0~18.0MS/ 0~612CM/ 0~240 INCH |
| DISTANCE (NET 3-WAY) | CH1 FL-TW | 0~18.0MS/ 0~612CM/ 0~240 INCH |
| | CH2 FR-TW | 0~18.0MS/ 0~612CM/ 0~240 INCH |
| | CH3 FL-MD | 0~18.0MS/ 0~612CM/ 0~240 INCH |
| | CH4 FR-MD | 0~18.0MS/ 0~612CM/ 0~240 INCH |
| | CH5 FL-WF | 0~18.0MS/ 0~612CM/ 0~240 INCH |
| | CH6 FR-WF | 0~18.0MS/ 0~612CM/ 0~240 INCH |
| | CH8 SUB | 0~18.0MS/ 0~612CM/ 0~240 INCH |
| DIA RST | NO/YES | |

DTA SETTINGS:

- 1.Press the knob to enter the [MENU].
- 2.Turn the knob to select [DTA SET], then press the knob.

Car Type Settings

- 1.Turn the knob to select [CAR TYPE], then press the knob.
- 2.Turn the knob to select [SMALL /MEDIUM /LARGE].

Listening Position Settings

- 1.Turn the knob to select [POSITION], then press the knob.
- 2.Turn the knob to select [USER/FRONT R/FRONT L/CENTER].

Delay Unit Settings

- 1.Turn the knob to select [UNIT], then press the knob.
- 2.Turn the knob to select [MS/CM/INCH].

Distance Net 4.2 Settings

- 1.Turn the knob to select [DISTANCE], then press the knob.
- 2.Turn the knob to select [CH1~CH8], then press the knob.
- 3.Turn the knob to select[0~18.0MS/ 0~612CM/ 0~240 INCH].

Distance Net 2-Way Settings

- 1.Turn the knob to select [DISTANCE], then press the knob.
- 2.Turn the knob to select [CH1~CH8], then press the knob.
- 3.Turn the knob to select[0~18.0MS/ 0~612CM/0~240 INCH].

Distance Net 3-Way Settings

- 1.Turn the knob to select [DISTANCE], then press the knob.
- 2.Turn the knob to select [CH1~CH8], then press the knob.
- 3.Turn the knob to select[0~18.0MS/ 0~612CM/ 0~240 INCH].

Note: Net 4.2/Net 2-Way /Net 3-Way can be set in the "XOVER" option.

DTA Reset

- 1.Turn the knob to select [DTA RST], then press the knob.
- 2.Turn the knob to select [NO/YES].

TIME ALIGNMENT(DISTANCE):

- 1.Press the knob to enter the [MENU].
- 2.Turn the knob to select [DTA SET], then press the knob.
- 3.Turn the knob to select [DISTANCE], then press the knob.
- 4.Turn the knob to select[F LEFT/F RIGHT/R LEFT/R RIGHT/SUBWOOFER] to adjustment.

Determining the value for<Position> adjustment.

- ① Determine the center of the currently set listening position as the reference point.
- ② The adjustable speaker has five directions: front left, front right, back left, back right, and back.
- ③ The time for the speakers in the five directions to reach the center is the same by default.
- ④ Set the value for each speaker, the delay range: 0-20ms.
- ⑤ Adjust the increase or decrease of each speaker, 0.2ms each time.

Example: When <back> is selected as the listening position:

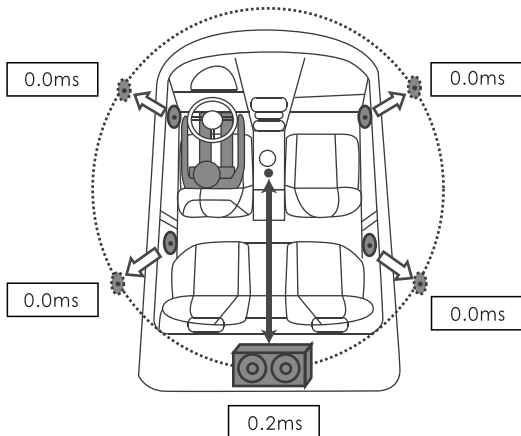

CLOCK AND DATE SETTINGS:

1. Press the knob to enter the [MENU].
2. Turn the knob to select [CLOCK], then press the knob.

Clock And Date Settings List

| Menu | Adjustment |
|------------|-------------------|
| CLK FORMAT | 12H/24H |
| CLK ADJ | 00:00 |
| DATE FRMT | DD-MM-YY/MM-DD-YY |
| DATE SET | 01/01/23 |

Clock Format Settings

1. Turn the knob to select [CLK FORMAT], then press the knob.
2. Turn the knob to select [12H/24H].

Clock Adjust

1. Turn the knob to select [CLK ADJ], then press the knob.
2. Turn the knob to adjustment.
3. Press the knob to switch the clock/minute adjustment.

Date Format Settings

1. Turn the knob to select [DATE FORMAT], then press the knob.
2. Turn the knob to select [DD-MM-YY/MM-DD-YY].

Date Settings

1. Turn the knob to select [DATE SET], then press the knob.
2. Turn the knob to adjustment.
3. Press the knob to switch day/month/year adjustment.

TUNER SETTINGS:

1. Press the knob to enter the [MENU].
2. Turn the knob to select [TUNER], then press the knob.

Tuner Settings List

| Menu | Adjustment | |
|-------|---------------------------------|--|
| TUNER | MONO/STEREO | NEWS/AFFAIRS/INFO/SPORT |
| | DX/LOCAL | EDUCATE/DRAMA/CULTURE |
| | RDS OFF/ON | SCIENCE/VARIED/POP M/ ROCK M/EASY M/LIGHT M/ CLASSICS/OTHER M/WEATHER/ FINANCE/CHILDREN/SOCIAL/ RELIGION /PHONE IN/TRAVEL/ LEISURE/JAZZ/COUNTRY/ NATION M/OLDIES/FOLK M/ DOCUMENT |
| | TA OFF/ON | |
| | AF ON/OFF | |
| | EON OFF/ON | |
| | REG OFF/ON | |
| | PTY OFF/ON | |
| | REGIONAL EUROPE/USA/ASIA/RUSSIA | |

TUNER SETTINGS:

Stereo/Mono Select

Turn the knob to select [STEREO or MONO], then turn the knob select [STEREO/MONO].

DX/Local Select

Turn the knob to select [LOC or DX], then turn the knob select [DX /LOCAL].
Remark: DX:Distant exchange.

RDS ON/OFF

Turn the knob to select [RDS OFF], then turn the knob select [RDS OFF, ON].

Tuner Area Select

Turn the knob to select [REGIONAL], then turn the knob select [ASIA/RUSSIA/EUR/USA].

DISPLAY SETTINGS:

- 1.Press the knob to enter the [MENU].
- 2.Turn the knob to select [DISPLAY], then press the knob.

Display Settings List

| Menu | Adjustment |
|----------|--|
| MODE SEL | C-MODE1/C-MODE2/MODE3/ |
| COLOR | AUTO/RED/GREEN/BLUE/YELLOW/ CYAN/PURPLE/WHITE |
| SPECTRUM | C-MODE1 |
| ID3 TAG | OFF/ON |

Key Light Select

- 1.Turn the knob to select [COLOR SEL], then press the knob.
- 2.Turn the knob to select key light color:[AUTO/RED/GREEN /BLUE/YELLOW/CYAN/PURPLE/WHITE].

Spectrum ON/OFF

- 1.Turn the knob to select [SPECTRUM], then press the knob.
- 2.Turn the knob to select [OFF/ON].

ID3 ON/OFF

- 1.Turn the knob to select [ID3 TAG], then press the knob.
- 2.Turn the knob to select [OFF/ON].

System Version

Turn the knob to select [VERSION], then press the button to query the system version information.

TROUBLE SHOOTING:

Not work

Fuse blown
Loose panel contact

Remedy

Replace the fuse: small 25A(white)
Take out the panel and reinstall

Not responding

System problem

Reset the unit

No bass

Subwoofer setting level
is too small

Enter AUDIO to set SVOL

Can't turn on voice

Bluetooth is not connected
Phone does not support voice

Connect Bluetooth
N.A

Not playing

Incorrect device format
Device error
Unsupported audio file

Reformat
Replacement device
Replace supported audio files

Radio reception is poor

Poor contact of radio antenna
Poor signal at location

Reconnect the radio antenna
Change to other positions

Remote control is invalid

Remote control battery is low

Replace CR2025 battery

Bluetooth call is poor

Microphone is too far away

Speak into the microphone

SPEAKER CONNECTION:

Do not connect the speaker leads of the power cord to the car battery; otherwise, the unit will be seriously damaged.

Before oconnecting the speak leads of the power cord to the speakers, check the speaker wiring in your car.

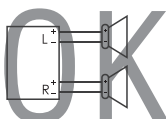
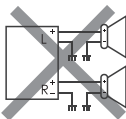
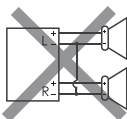

SPECIFICATION:

| | | |
|---------|--------------------------|------------------------|
| GENERAL | Operating Voltage | 14.4V(10.8V allowable) |
| | Maximum Current | 25A |
| | Operational Temperature | -10°~+60° |
| | Installation Size(WxHxD) | 182mmx53mmx115mm |
| | Net Weight | 0.6kg |
| | Fuse | Small fuse 25A (white) |

| | | |
|-------|----------------------|--------|
| AUDIO | Maximum Output Power | 100Wx4 |
| | Speaker Impedance | 4-8ohm |
| | Pre-output Level | 4v |

| | | |
|-------|--------------------|------------------|
| RADIO | FM Frequency Range | 87.5MHz-108.0MHz |
| | AM Frequency Range | 522KHz-1710KHz |
| | Preset | 18FM, 12AM |

| | | |
|-----|--------------|----------------------------------|
| USB | USB Standard | USB1.1, USB2.0 Full Speed |
| | Audio Format | MP3/WMA/APE/FLAC/ AAC/M4A/WAV |
| | USB | Charge DC 5V=2A |

| | | |
|-----------|---------------------|--------------------------|
| BLUETOOTH | Version | Bluetooth 5.0 |
| | Frequency Range | 2.402GHz-2.480GHz |
| | Communication Range | Line of sight approx.10m |
| | Profile | HPF1.6/A2DP/AVR/SPP |