

# FOR-X

www.for-x.com.tr

## Owner's Manual

# X-100MIC

## CAR KARAOKE MP3 PLAYER



App Store



Google Play



**CONTENTS:**

Warnings&Precautions .....	01
Product Features .....	01
Installation.....	02
Accessorylist.....	03
Dimension(UNIT:MM) .....	03
Wiring Diagram .....	04
Remote Operation .....	05
Bluetooth Operation .....	05
Karaoke.....	06
USB&SD Playback.....	06
Radio Operation .....	07
AUX Input.....	07
External Microphone .....	08
Xover Setup.....	08
Audio Setting .....	09
Audio Setting .....	10
Clock And Date Setting.....	10
Animation Setting .....	11
Tuner Setting.....	11
Demo Mode Select .....	11
Display Setting.....	12
Trouble Shooting.....	13
Speaker Connection .....	13
Specification.....	14
APP Operation.....	15

## **WARNINGS & PRECAUTIONS:**

To avoid risk of serious injury or possible violation of laws, please read the following thoroughly before installation or connecting.

- This product is designed specifically for use with 12 volt, negative ground electrical systems only.
- Having the wiring and installation done by expert.  
Be sure to disconnect the cable from the negative battery terminal while installtion.
- This apparatus shall not be exposed to dripping or splashing, and no object filled with liquids shall be placed on the apparatus.
- Fuses shall be replaced only with the correct type and fuse value, and only when the apparatus is powered off.
- To prevent a short circuit, never put or leave any metallic objects(such as coins or metallic tools)inside the unit.
- Never set the volume of this product so high that you cannot hear outside traffic and emergency vehicles.

## **PRODUCT FEATURES:**

**LCD:** VA-LCD

**DSP:** Built-in

**Key Light:** Multi Color

**Bluetooth:** Version 5.1

**Remote:** Support

**Pre-Output:** 6CH x 3V

**AUX In:** Support

**SD Card:** Support

**Bluetooth Music:** Support

**EQ:** 28 Band/8 Preset

**Radio:** FM

**USB:** Charge 2A

**APP Control:** iOS and Android Phone

**Max Power:** 4 x 60W

**Subwoofer Control:** Support

**Dual Bluetooth Connection:** Support

**Audio Format:** MP3/WMA/AAC/FLAC

**External Microphone:** Support

## INSTALLATION:

### Installation Procedures

First complete the electrical connections and then check for correctness.

### Installation Opening

This unit can be installed in any dashboard has an opening as shown below:

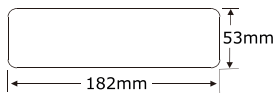

### TO Install The Car Radio

Be sure you test all connections first, and then follow these steps to install this unit.

1. Make sure the ignition is turned off, and then disconnect the cable from the vehicle battery's negative (-) terminal.
2. Disconnect the wire harness and the antenna.
3. Remove the detachable panel and decorative enclosure frame and place on one side.
4. Insert the two brackets into the left and right sides of the chassis, as shown in the following figure, and separate the chassis from the sleeve.

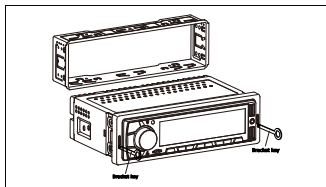

5. Insert the installation sleeve into the center console to be installed, and bend the clip using a screwdriver. Make sure the locking rod is flush with the mounting sleeve and does not protrude.
6. Connect cables as shown in the Wiring diagram.
7. Insert the car radio into the mounting sleeve.
8. Install decorative enclosure frame.

## ACCESSORY LIST:

Please check the following accessories after opening the package:

ISO Male Connector x2

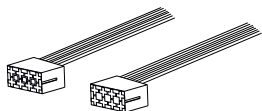

Remote x1



Disassemble Keys X2



User Manual / Warranty Card / Service Manual



## DIMENSION(UNIT:MM):

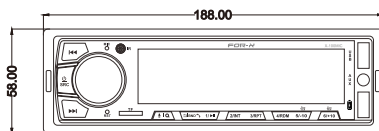
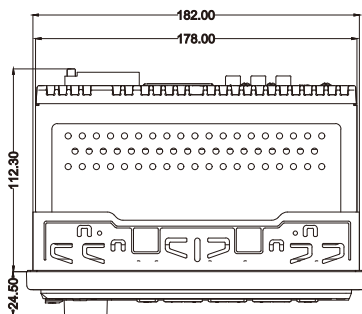
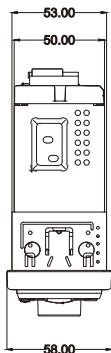

## WIRING DIAGRAM:

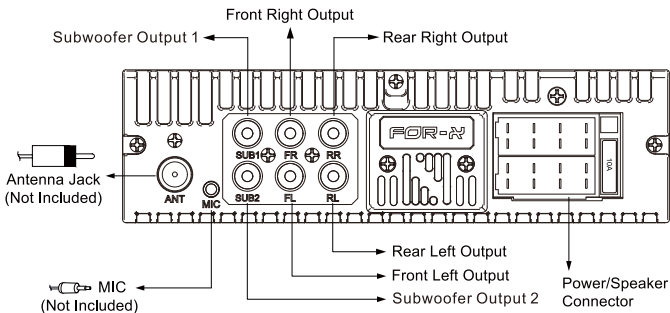

### POWER & SPEAKER CONNECTOR

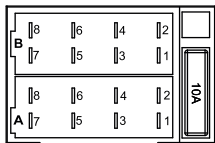

#### Socket A(Power Supply):

- A1: GND
- A2: Ignition Wire
- A3: NA
- A4: Amplifier Control
- A5: Battery (+)
- A6: SWC Control Wire 1
- A7: SWC Control GND
- A8: SWC Control Wire 2

#### Socket B(Speakers):

- B1: Rear Left (-)
- B2: Rear Left (+)
- B3: Front Left (-)
- B4: Front Left (+)
- B5: Front Right (-)
- B6: Front Right (+)
- B7: Rear Right (-)
- B8: Rear Right (+)

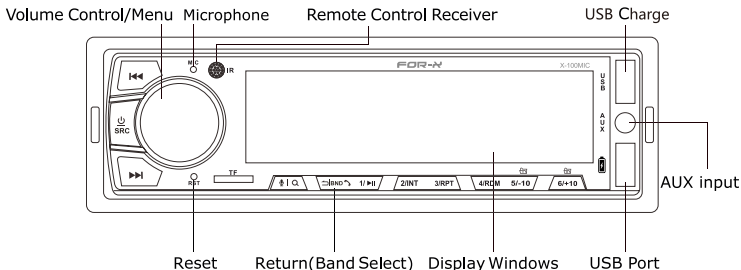

## REMOTE OPERATION:

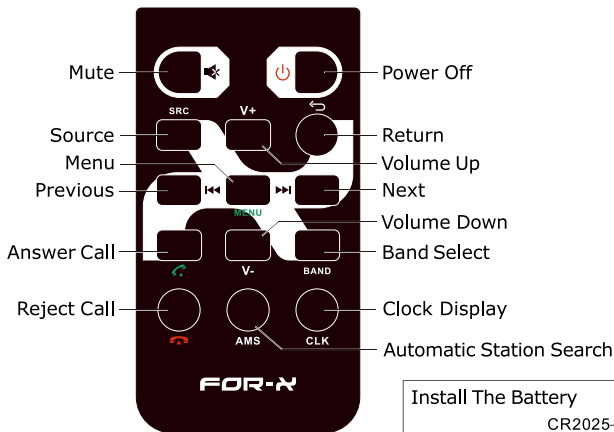

### Install The Battery

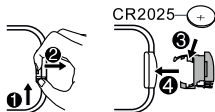

## BLUETOOTH OPERATION:

### Bluetooth Pairing

The first time pair mobile phone with receiver, please follow below steps:

1. When there is no pairing, in any mode, the BT on the LCD will flash, and the pairing can be performed at this time.
2. Turn on the phone's Bluetooth to search X-100MIC.
3. Click on the X-100MIC on the phone to connect. After the connection is successful, the BT will stop flashing.
4. When pairing is completed, the mobile phone audio will transfer to the car audio system automatically whenever a call is made or received, or when the mobile phone plays music.

### Note:

For more details of bluetooth pairing, please refer to the owner's manual for your mobile phone.

## KARAOKE:



## Introduction of Microphone Functions

Function Name	Function Introduction
VOICE	Cancel Music Vocals
VOLUME	Mic Volume
ECHO	Mic Reverberation
MAGIC	Mic Voice Change

## USB&SD PLAYBACK:

To	Operation (panel)
Track selection	Press <b>⏮</b> <b>⏭</b>
fast playback	Press and hold <b>⏮</b> <b>⏭</b>
Playback/Pause	Press <b>1/⏩</b>
Track pre-play	Press <b>2/INT</b>
Repeat playback	Press <b>3/RPT</b> ● REPEAT ONE.REPEAT DIR.REPEAT ALL
Random playback	Press <b>4/RDM</b> ● ON/OFF
Folder selection	Press <b>5/-10</b> <b>📁</b> <b>6/+10</b> <b>📁</b>



## RADIO OPERATION:

### Start Listening

To	Operation (panel)	Remark
Auto memory	Press and hold $\downarrow$ I Q	18 FM
Band selection	Press $\rightarrow$ BAND $\leftarrow$	FM1/FM2/FM3
Seek a station manually	Press $\lll$ $\ggg$	
Search the next or previous frequency step by step	Press and hold $\lll$ $\ggg$	
Store a station	Press and hold 1-6	

RADIO	
FM Frequency Range	Europe Area: 87.5 ~ 108.0 KHz (50KHz / Step)
	U.S.A Area: 87.5~107.9 KHz (200 KHz / Step)
	ASIA Area: 87.5~108.0 KHz (100 KHz / Step)
	RUSS Area: 65.0 ~74.0 KHz (30 KHz/ Step)
Preset	18FM

## AUX INPUT:

1.Connect a portable audio player(commercially available).

Auxiliary input jack

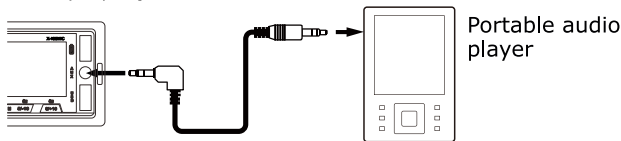

Auxiliary input jack

3.5mm stereo mini plug with "L" shaped connector.  
(commercially available).

2.Press[  $\downarrow$  SRC ] buttons to select AUX IN.

3.Turn on the portable audio player and start playback.

## EXTERNAL MICROPHONE:

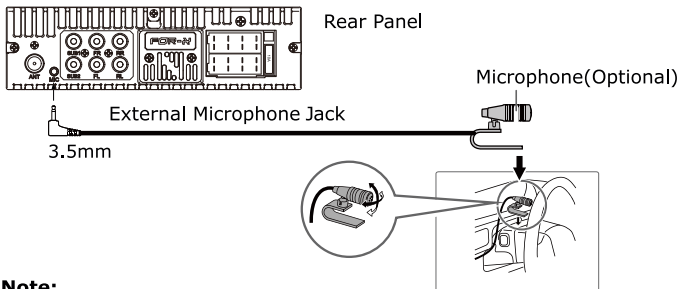

### Note:

Since the panel microphone is far from the driver's position, when using an external microphone, you can get better voice calls.

## XOVER SETUP:

1. Press the knob to enter the [MENU].
2. Turn the knob to select [X/OVER], then press the knob.
3. Turn the knob to select [SUB SET], then press the knob.

### Subwoofer Xover List

Menu	Adjustment	
F+R SET	HPF FREQ	OFF/30HZ/40HZ/50HZ/63HZ/70HZ/80HZ/90HZ/100HZ/125HZ/160HZ/180HZ/220HZ/250HZ/315HZ/400HZ/500HZ/630HZ/700HZ/800HZ
	LPF FREQ	OFF/1KHZ/1.6KHZ/2.5KHZ/3.15KHZ/4KHZ/5KHZ/6.3KHZ/8KHZ/110KHZ/12.5KHZ

### Front & Rear HPF Frequency Setup

1. Turn the knob to select [HPF FREQ], then press the knob.
2. Turn the knob to select frequency [OFF/30HZ/40HZ/50HZ/63HZ/70HZ/80HZ/90HZ/100HZ/125HZ/160HZ/180HZ/220HZ/250HZ/315HZ/400HZ/500HZ/630HZ/700HZ/800HZ].

### Front & Rear LPF Frequency Setup

1. Turn the knob to select [LPF FREQ], then press the knob.
2. Turn the knob to select frequency [OFF/1KHZ/1.6KHZ/2.5KHZ/3.15KHZ/4KHZ/5KHZ/6.3KHZ/8KHZ/110KHZ/12.5KHZ]

**AUDIO SETTING:**

1. Press the knob to enter the [MENU].
2. Turn the knob to select [AUDIO], then press the knob.

**Audio Setting List**

Menu	Adjustment
SW LEVEL	SVOL -8 ~ +8
PRESET EQ	USER/NATURAL/POP/CLASSIC/ROCK/JAZZ/FLAT/ COUNTRY/OPTIMAL └─ 30HZ/60HZ/80HZ/120HZ/160HZ/250HZ/400HZ/600HZ/ 1.5KHZ/2KHZ/2.5KHZ/3KHZ/3.5K/4K/5K/6K/7K/8K/9K/11K/ 12K/13K/14K/15K/16K/17K/18K/19K
LOUDN	OFF/ON
BASS	BASS -7 ~ +7
MIDDLE	MIDDLE -7 ~ 7
TONE	TONE -7 ~ 7
TREBLE	TREBLE -7 ~ +7
BALAN	BALAN L7-L0, 0, R1-R7
FADER	FADER R7-R1, 0, F1-F7
AUDIO RESET	NO/YES

**Subwoofer Volume Adjustment**

1. Turn the knob to select [SW LEVEL], then press the knob.
2. Turn the knob to adjust SVOL [ -8 to +8].

**Preset EQ Select**

1. Turn the knob to select [PRESET EQ ], then press the knob.
2. Turn the knob to select [USER/NATURAL/POP/CLASSIC/ROCK/  
JAZZ/FLAT/COUNTRY/OPTIMAL].

**User EQ Setup**

1. Turn the knob to select [PRESET EQ ], then press the knob.
2. Turn the knob to select [USER], then press the knob.
3. Turn the knob to select frequency for adjustment.

**Loudness Setup**

1. Turn the knob to select [LOUDN], then press the knob.
2. Turn the knob to select [OFF/ON].

**Bass Adjustment**

1. Turn the knob to select [BASS], then press the knob.
2. Turn the knob to adjust [-7 to +7].

## AUDIO SETTINGS:

### Middle Adjustment

1. Turn the knob to select [MIDDLE] then press the knob.
2. Turn the knob to select [ -7 to +7 ].

### Tone Adjustment

1. Turn the knob to select [TONE], then press the knob.
2. Turn the knob to select [ -7 to +7 ].

### Treble Adjustment

1. Turn the knob to select [ TREBLE ], then press the knob.
2. Turn the knob to select [ -7 to +7 ].

### Balance Adjustment

1. Turn the knob to select [BALAN], then press the knob.
2. Turn the knob to select [ L7-L0 to R1-R7 ].

### Fader Adjustment

1. Turn the knob to select [ FADER ], then press the knob.
2. Turn the knob to select [ R7-R0 to F1-F7 ].

### Audio Setup

1. Turn the knob to select [ AUDIO RESET ], then press the knob.
2. Turn the knob to select [ NO/YES ].

## CLOCK AND DATE SETTING:

1. Press the knob to enter the [MENU].
2. Turn the knob to select [CLOCK], then press the knob.

### Clock And Date Settings List

Menu	Adjustment
CLOCK FORMAT	12H/24H
CLOCK ADJUST	00:00
DATE FORMAT	DD-MM-YY/MM-DD-YY
DATE SET	01/01/2023

### Clock Format Settings

1. Turn the knob to select [CLK FRMT], then press the knob.
2. Turn the knob to select [12H/24H].

### Clock Adjust

1. Turn the knob to select [CLK ADJ], then press the knob.
2. Turn the knob to adjustment.
3. Press the knob to switch the clock/minute adjustment.

### Date Format Settings

1. Turn the knob to select [DATE FORMAT], then press the knob.
2. Turn the knob to select [DD-MM-YY/MM-DD-YY].

### Date Settings

1. Turn the knob to select [DATE SET], then press the knob.
2. Turn the knob to adjustment.
3. Press the knob to switch day/month/year adjustment.

## ANIMATION SETTING:

1. Press the knob to enter the [MENU].
2. Turn the knob to select [ANIMATION], then press the knob.
3. Turn the knob to select [OFF/PER 15SEC/30SEC/1MIN/2MIN/4MIN].

Menu	Adjustment
ANIMATION	OFF/PER 15SEC/30SEC/1MIN/2MIN/4MIN

## TUNER SETTING:

1. Press the knob to enter the [MENU].
2. Turn the knob to select [TUNER], then press the knob.

### Tuner Setting List

Menu	Adjustment
TUNER	MONO/STEREO ST
	DX/LOC
	ARER EUROPE/USA/ASIA/RUSSIA

### Stereo/Mono Select

Turn the knob to select [STEREO or MONO], then turn the knob select [STEREO/MONO].

### DX/Local Select

Turn the knob to select [LOC or DX], then turn the knob select [DX /LOCAL].

Remark: DX:Distant exchange

### Tuner Area Select

Turn the knob to select [REGIONAL], then turn the knob select [ASIA/OIRT/EUR/USA].

## DEMO MODE SELECT:

1. Press the knob to enter the [MENU].
2. Turn the knob to select [DEMO MODE], then press the knob.
3. Turn the knob to select [OFF/ON].

Menu	Adjustment
DEMO MODE	OFF/ON

## DISPLAY SETTING:

1. Press the knob to enter the [MENU].
2. Turn the knob to select [DISPLAY], then press the knob.

### Display Setting List

Menu	Adjustment
SPECTRUM	OFF/ON
ID3 TAG	OFF/ON
MODE SEL	C-MODE 1/C-MODE 2/C-MODE 3
C-MODE 1/ COLOR SEL	AUTO/RED/GREEN/BLUE/YELLOW/ CYAN/PURPLE/WHITE
VERSION	VER 1.0

### Spectrum ON/OFF

1. Turn the knob to select [SPECTRUM], then press the knob.
2. Turn the knob to select [OFF/ON].

### ID3 ON/OFF

1. Turn the knob to select [ID3 TAG], then press the knob.
2. Turn the knob to select [OFF/ON].

### Key Light Select

1. Turn the knob to select [MODE SEL], then press the knob.
2. Turn the knob to select [C-MODE 1/C-MODE 2/C-MODE 3].

### Key Light Bright Setup

1. Turn the knob to select [BRIGHT], then press the knob.
2. Turn the knob to select [MANUAL], then press the knob.
3. Turn the knob to select [M-LEVER 1~8].
4. Turn the knob to select [AUTO], then press the knob.
5. Turn the knob to select [A-LEVER 1~8], then press the knob.
6. Turn the knob to select [START], then press the knob to set start time.
7. Turn the knob to select [STOP], then press the knob to set stop time.

### System Version

Turn the knob to select [VERSION], then press the button to query the system version information.

## TROUBLE SHOOTING:

### Not work

Fuse blown  
Loose panel contact

### Remedy

Replace the fuse: 10A(Red)  
Take out the panel and reinstall

### Not responding

System problem

Reset the unit

### No bass

Subwoofer setting level  
is too small

Enter AUDIO to set SVOL

### Can't turn on voice

Bluetooth is not connected  
Phone does not support voice

Connect Bluetooth  
N.A

### Not playing

Incorrect device format  
Device error  
Unsupported audio file

Reformat  
Replacement device  
Replace supported audio files

### Radio reception is poor

Poor contact of radio antenna  
Poor signal at location

Reconnect the radio antenna  
Change to other positions

### Remote control is invalid

Remote control battery is low

Replace CR2025 battery

### Bluetooth call is poor

Microphone is too far away

Speak into the microphone

## SPEAKER CONNECTION:

Do not connect the speaker leads of the power cord to the car battery; otherwise, the unit will be seriously damaged.

Before connecting the speaker leads of the power cord to the speakers, check the speaker wiring in your car.

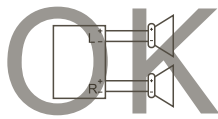
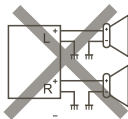
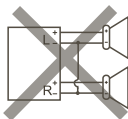

**SPECIFICATION:**

<b>GENERAL</b>	Power Supply Requirement	DC 12V
	Maximum Power Output	60W X 4CH
	Speaker Impedance	4 - 8 Ohm
	Unit Dimensions(WxHxD)	178 X 112.3 X 50mm
	Weight	0.6 kg
	Fuse	10 A

<b>RADIO</b>	FM Frequency Range	87.5MHz - 108.0MHz
	Preset	

<b>USB Index</b>	Usable Audio Formats:	MP3/WMA
	USB Port Type:	2.0
	USB Charging:	5V/2A
	Frequency Response:	20 Hz - 20 KHz
	S/N Ratio:	60 dB

<b>BLUETOOTH</b>	Version	Bluetooth 5.1
	BT Profile Supports:	A2DP, AVRCP, HFP
	Range Of Frequency:	2.4 GHz spectrum





## **APP OPERATION:**

### **APP Download**

Method 1: Please scan the QR code on the cover to download the APP and install it on your Android or Apple device.

Method 2: Please go to the Apple APP Store or Google Play Store and search [AUDIO DSP Control] APP, after downloading the APP, install it on your Apple & Android devices.

### **APP Connection**

- 1.Open the [AUDIO DSP Control] APP, click to search for X-100MIC .
- 2.Click X-100MIC to connect, the  will be red after the connect is successful.

