

FOR-X

www.for-x.com.tr

Owner's Manuel

X-510DSP DIGITAL MEDIA RECEIVER



App Store



Google Play

CE

CONTENTS:

Warnings&Precautions	01
Product Features	01
Installation.....	02
Accessorylist.....	03
Dimension(UNIT:MM)	03
Wiring Diagram	04
Remote Operation	05
Bluetooth Operation	05
Radio Operation	06
USB&SD Playback.....	06
AUX Input.....	07
External Microphone	07
Audio Settings.....	08
Clock And Date Settings	09
Xover Setup.....	10
Dta Settings.....	11
Animation Settings	11
Time Alignment(DISTANCE)	12
Tuner Settings.....	13
Demo Mode Select	13
Display Settings.....	14
Trouble Shooting.....	15
Speaker Connection	15
Specification.....	16
APP Operation.....	17

WARNINGS & PRECAUTIONS:

To avoid risk of serious injury or possible violation of laws, please read the following thoroughly before installation or connecting.

- This product is designed specifically for use with 12 volt, negative ground electrical systems only.
- Having the wiring and installation done by expert.
Be sure to disconnect the cable from the negative battery terminal while installation.
- This apparatus shall not be exposed to dripping or splashing, and no object filled with liquids shall be placed on the apparatus.
- Fuses shall be replaced only with the correct type and fuse value, and only when the apparatus is powered off.
- To prevent a short circuit, never put or leave any metallic objects (such as coins or metallic tools) inside the unit.
- Never set the volume of this product so high that you cannot hear outside traffic and emergency vehicles.

PRODUCT FEATURES:

LCD: VA-LCD

DSP: Built-in

Key Light: Multi Color

Bluetooth: Version 5.1

Remote: Support

Pre-Output: 6CH x 4V

Time Alignment: Support

AUX In: Support

SD Card: Support

Bluetooth Music: Support

EQ: 28 band/9 Preset

Radio: FM/AM/RDS

USB: Charge 2A

APP Control: iOS and Android Phone

Max Power: 4 x 60W

Subwoofer Control: Support

Dual Bluetooth Connection: Support

SWIControl: Support

Audio Format: MP3/WMA/AAC/FLAC

External Microphone: Support

INSTALLATION:

Installation Procedures

First complete the electrical connections and then check for correctness.

Installation Opening

This unit can be installed in any dashboard Having an opening as shown below:

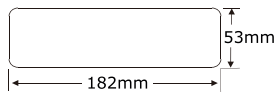

TO Install The Car Radio

Be sure you test all connections first, and then follow these steps to install this unit.

1. Make sure the ignition is turned off, and then disconnect the cable from the vehicle battery' s negative (-) terminal.
2. Disconnect the wire harness and the antenna.
3. Remove the detachable panel and decorative enclosure frame and place on one side.
4. Insert the two brackets into the left and right sides of the chassis, as shown in the following figure, and separate the chassis from the sleeve.

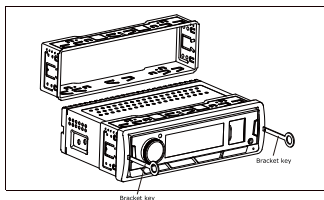

5. Insert the installation sleeve into the center console to be installed, and bend the clip using a screwdriver. Make sure the locking rod is flush with the mounting sleeve and does not protrude.
6. Connect cables as shown in the Wiring diagram.
7. Insert the car radio into the mounting sleeve.
8. Install decorative enclosure frame.

ACCESSORY LIST:

Please check the following accessories after opening the package:

ISO Male Connector x2

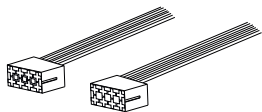

Remote x1



Disassemble keys x2

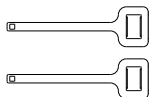

User Manual / Warranty Card / Service Manual



DIMENSION(UNIT:MM):

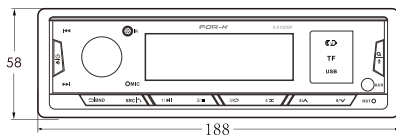
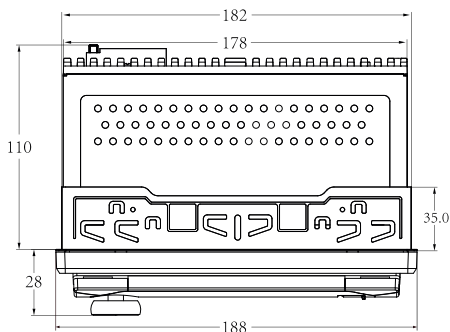
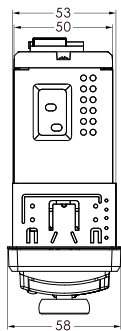

WIRING DIAGRAM:

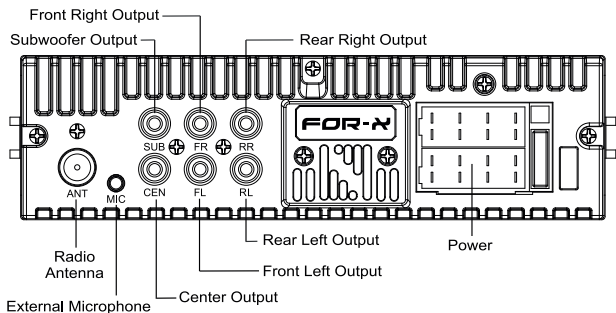

POWER/SPEAKER CONNECTOR

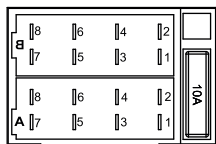

Socket A (Power Supply):

- A1: GND
- A2: Ignition Wire
- A3: NA
- A4: Amplifier Contro
- A5: Battery (+)
- A6: SWI Control Wire 1
- A7: SWI Control GND
- A8: SWI Control Wire 2

Socket B (Speakers):

- B1: Rear Left (-)
- B2: Rear Left (+)
- B3: Front Left (-)
- B4: Front Left (+)
- B5: Front Right (-)
- B6: Front Right (+)
- B7: Rear Right (-)
- B8: Rear Right (+)

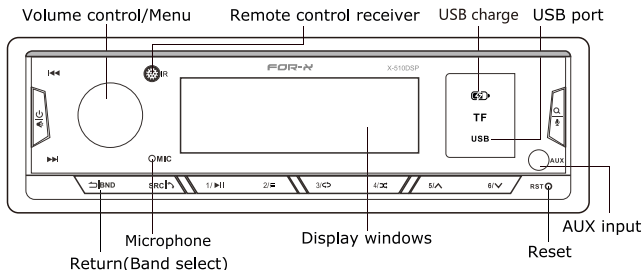

REMOTE OPERATION:

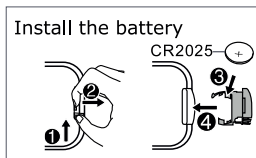
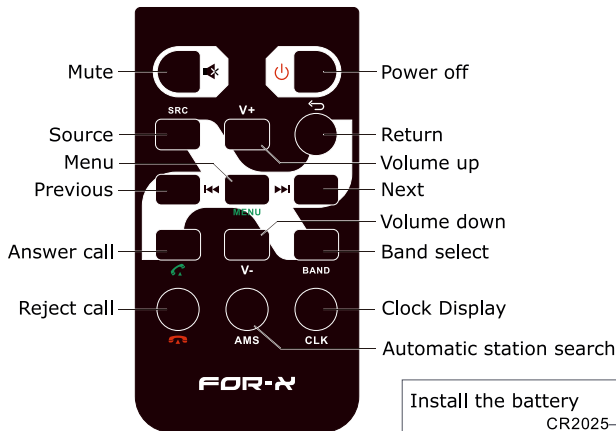

BLUETOOTH OPERATION:

Bluetooth Pairing

The first time pair mobile phone with receiver, please follow below steps:

1. When there is no pairing, in any mode, the BT on the LCD will flash, and the pairing can be performed at this time.
2. Turn on the phone's Bluetooth to Search X-510DSP.
3. Click on the X-510DSP on the phone to connect. After the connection is successful, the BT will stop flashing.
4. When pairing is complete, the mobile phone audio will automatically transfer to the car audio system whenever a call is made or received, or when the mobile phone plays music.

Note:

For more details of bluetooth pairing, please refer to the owner's manual for your mobile phone.

RADIO OPERATION:

Start Listening

To	Operation (panel)	Remark
Auto memory	Press and hold $\frac{\text{A}}{\text{F}}$	18 FM/12AM
Band selection	Press \rightarrow /BND	FM1/FM2/FM3/AM1/AM2
Seek a station manually	Press $\lll \ggg$	
Search the next or previous frequency step by step	Press and hold $\lll \ggg$	
Store a station	Press and hold 1-6	

RADIO

FM Frequency Range	Europe Area: 87.5 ~ 108.0 KHz (50KHz / Step)
	U.S.A.Area: 87.5~107.9 KHz (200 KHz / Step)
	ASIA Area: 87.5~108.0 KHz (100 KHz / Step)
	RUSS Area: 65.0 ~74.0 KHz (30 KHz/ Step)
Preset	18FM / 12AM

USB&SD PLAYBACK:

To	Operation (panel)
Track selection	Press $\lll \ggg$
Fast playback	Press and hold $\lll \ggg$
Playback/Pause	Press 1/ \ggg
Track pre-play	Press 2/ \equiv
Repeat playback	Press 3/ \leftrightarrow <ul style="list-style-type: none"> ● REPEAT ONE.REPEAT DIR.REPEAT ALL
Random playback	Press 4/ \boxtimes <ul style="list-style-type: none"> ● ON/OFF
Folder selection	Press 5/ \wedge 6/ \vee

AUX INPUT:

- 1.Connect a portable audio player(commmercially available).
Auxiliary input jack

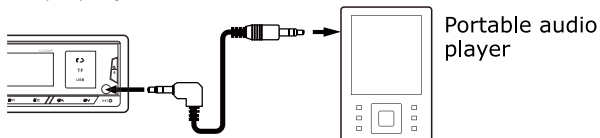

Auxiliary input jack

3.5mm stereo mini plug with "L" shaped connector.

(commercially available).

- 2.Press[src] buttons to select AUX IN.

- 3.Turn on the portable audio player and start playback.

EXTERNAL MICROPHONE:



Rear Panel

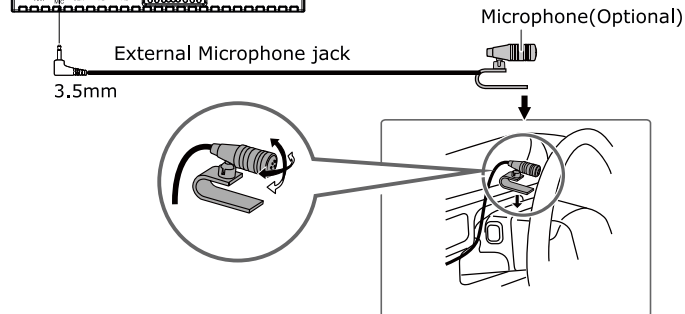

Note:

Since the panel microphone is far from the driver's position, when using an external microphone, you can get better voice calls.

AUDIO SETTINGS:

1. Press the knob to enter the [MENU].
2. Turn the knob to select [AUDIO], then press the knob.

Audio Settings List

Menu	Adjustment
SW LEVEL	SVOL -8 ~ +8
PRESET EQ	USER/NATURAL/POP/CLASSIC/ROCK/JAZZ/FLAT/ COUNTRY/OPTIMAL └ 30HZ/60HZ/80HZ/120HZ/160HZ/250HZ/400HZ/600HZ/ 1.5KHZ/2KHZ/2.5KHZ/3KHZ/3.5K/4K/5K/6K/7K/8K/9K/11K/ 12K/13K/14K/15K/16K/17K/18K/19K
LOUD	OFF/ON
BASS	BASS -7 ~ +7
MIDDLE	MIDDLE -7 ~ 7
TONE	TONE -7 ~ 7
TREBLE	TREBLE -7 ~ +7
BALAN	BALAN L7-L0, 0, R1-R7
FADER	FADER R7-R1, 0, F1-F7
AUDIO RESET	NO/YES

Subwoofer Volume Adjustment

1. Turn the knob to select [SW LEVEL], then press the knob.
2. Turn the knob to adjustment SVOL [-8 to +8].

Preset EQ Select

1. Turn the knob to select [PRESET EQ], then press the knob.
2. Turn the knob to select [USER/NATURAL/POP/CLASSIC/ROCK/
JAZZ/FLAT/COUNTRY/OPTIMAL].

User EQ Setup

1. Turn the knob to select [PRESET EQ], then press the knob.
2. Turn the knob to select [USER], then press the knob.
3. Turn the knob to select frequency for adjustment.

Loudness Setup

1. Turn the knob to select [LOUD], then press the knob.
2. Turn the knob to select [OFF/ON].

Bass Adjustment

1. Turn the knob to select [BASS], then press the knob.
2. Turn the knob to adjustment [-7 to +7].

AUDIO SETTINGS:

Middle Adjustment

1. Turn the knob to select [MIDDLE] then press the knob.
2. Turn the knob to select [-7 to +7].

Tone Adjustment

1. Turn the knob to select [TONE], then press the knob.
2. Turn the knob to select [-7 to +7].

Treble Adjustment

1. Turn the knob to select [TREBLE], then press the knob.
2. Turn the knob to select [-7 to +7].

Balance Adjustment

1. Turn the knob to select [BALAN], then press the knob.
2. Turn the knob to select [L7-L0 to R1-R7].

Fader Adjustment

1. Turn the knob to select [FADER], then press the knob.
2. Turn the knob to select [R7-R0 to F1-F7].

Audio Setup Reset

1. Turn the knob to select [AUDIO RESET], then press the knob.
2. Turn the knob to select [NO/YES].

CLOCK AND DATE SETTINGS:

1. Press the knob to enter the [MENU].
2. Turn the knob to select [CLOCK], then press the knob.

Clock And Date Settings List

Menu	Adjustment
CLOCK FORMAT	12H/24H
CLOCK ADJUST	00:00
DATE FORMAT	DD-MM-YY/MM-DD-YY
DATE SET	01/01/2023

Clock Format Settings

1. Turn the knob to select [CLK FRMT], then press the knob.
2. Turn the knob to select [12H/24H].

Clock Adjust

1. Turn the knob to select [CLK ADJ], then press the knob.
2. Turn the knob to adjustment.
3. Press the knob to switch the clock/minute adjustment.

Date Format Settings

1. Turn the knob to select [DATE FORMAT], then press the knob.
2. Turn the knob to select [DD-MM-YY/MM-DD-YY].

Date Settings

1. Turn the knob to select [DATE SET], then press the knob.
2. Turn the knob to adjustment.
3. Press the knob to switch day/month/year adjustment.

XOVER SETUP:

1. Press the knob to enter the [MENU].
2. Turn the knob to select [X/OVER], then press the knob.
3. Turn the knob to select [SUB SET], then press the knob.

Subwoofer Xover List

Menu	Adjustment	
F+R SET	HPF FREQ	OFF/30HZ/40HZ/50HZ/63HZ//80HZ/100HZ/ /125HZ/160HZ/200HZ/250HZ/
	LPF FREQ	OFF/1KHZ/1.6KHZ/2.5KHZ/3.15KHZ/4K/ 5KHZ/6.3KHZ/8KHZ110KHZ/12.5KHZ
SUB SET	FRQ THROUGH	32HZ/40HZ/50HZ/63HZ/80HZ/100HZ/ 125HZ/160HZ/200HZ/250HZ
	SW PHASE	NORMAL/REVERSE
	SW GAIN	GAIN -8 ~ 8

Front&Rear HPF Frequency Setup

1. Turn the knob to select [HPF FREQ], then press the knob.
2. Turn the knob to select frequency [OFF/30HZ/40HZ/50HZ/63HZ/70HZ/
80HZ/90HZ/100HZ/125HZ/160HZ/180HZ/220HZ/250HZ/315HZ/400HZ/
500HZ/630HZ/700HZ/800HZ].

Front&Rear LPF Frequency Setup

1. Turn the knob to select [LPF FREQ], then press the knob.
2. Turn the knob to select frequency [FULL/1K/1.6K/2.5K/3.15K/4K/5K/
6.3K/8K/10K/12.5K].

Subwoofer Frequency Through Setup

1. Turn the knob to select [SW FRQ THROUGH], then press the knob.
2. Turn the knob to select frequency[32Hz/40Hz/50Hz/63Hz/80Hz/100Hz/
125Hz/160Hz/200H/250HZ].

Subwoofer Phase Setup

1. Turn the knob to select [SW PHASE], then press the knob.
2. Turn the knob to select [NORMAL/REVERSE].

Subwoofer Gain Setup

1. Turn the knob to select [SW GAIN], then press the knob.
2. Turn the knob to select [0-5].

DTA SETTINGS:

1. Press the knob to enter the [MENU].
2. Turn the knob to select [DTA SET], then press the knob.

DTA Settings List

Menu	Adjustment	
CAR TYPE	SMALL CAR/MEDIUM CAR/LARGE CAR	
POSITION	USER/FRONT R/FRONT L/CENTER	
DELAY UNIT	MS/CM/INCH	
DISTANCE	FRONT LEFT	FL 0CM - 680CM
	FRONT RIGHT	FR 0CM - 680CM
	REAR LEFT	RL 0CM - 680CM
	REAR RIGHT	RR 0CM - 680CM
DTA RST	NO/YES	

Car Type Settings

1. Turn the knob to select [CAR TYPE], then press the knob.
2. Turn the knob to select [SMALL /MEDIUM /LARGE].

Listening Position Settings

1. Turn the knob to select [POSITION], then press the knob.
2. Turn the knob to select [USER/FRONT R/FRONT L/CENTER].

Delay Unit Settings

1. Turn the knob to select [UNIT], then press the knob.
2. Turn the knob to select [CM/MS/INCH].

DSP Reset

1. Turn the knob to select [DTA RST], then press the knob.
2. Turn the knob to select [NO/YES].

ANIMATION SETTINGS:

1. Press the knob to enter the [MENU].
2. Turn the knob to select [ANIMATION], then press the knob.
3. Turn the knob to select [OFF/PER 15SEC/30SEC/1MIN/2MIN/4MIN].

Menu	Adjustment
ANIMATION	OFF/PER 15SEC/30SEC/1MIN/2MIN/4MIN

TIME ALIGNMENT(DISTANCE):

1. Press the knob to enter the [MENU].
2. Turn the knob to select [DTA SET], then press the knob.
3. Turn the knob to select [DISTANCE], then press the knob.
4. Turn the knob to select[F LEFT/F RIGHT/R LEFT/R RIGHT/SUBWOOFER] to adjustment.

Determining the value for<Position> adjustment.

- ① Determine the center of the currently set listening position as the reference point.
- ② The adjustable speaker has five directions: front left, front right, back left, back right, and back.
- ③ The time for the speakers in the five directions to reach the center is the same by default.
- ④ Set the value for each speaker, the delay range: 0-20ms.
- ⑤ Adjust the increase or decrease of each speaker, 0.2ms each time.
Example:When <back> is selected as the listening position

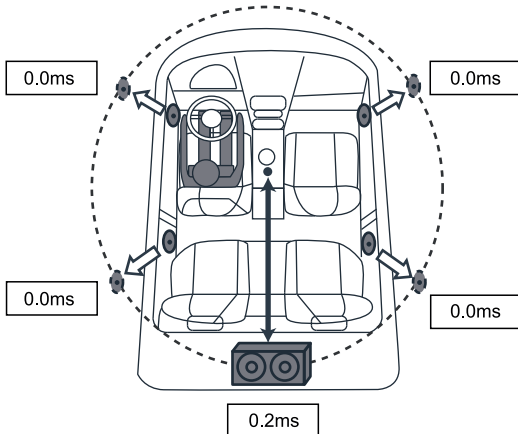

TUNER SETTINGS:

1. Press the knob to enter the [MENU].
2. Turn the knob to select [TUNER], then press the knob.

Tuner Settings List

Menu	Adjustment	
TUNER	MONO/STEREO ST	NEWS/AFFAIRS/INFO/SPORT
	DX/LOC	EDUCATE/DRAMA/CULTURE
	ARER EUROPE/USA/ASIA/RUSSIA	SCIENCE/VARIED/POP M/ROCK
	RDS ON/OFF	M/EASY M/LIGHT M/CLASSICS
	TA ON/OFF	OTHER M/WEATHER/FINANCE
	AF ON/OFF	CHILDREN/SOCIAL/RELIGION
	EON ON/OFF	PHONE IN/TRAVEL/LEISURE
	REG ON/OFF	JAZZ/COUNTRY/NATION M
	PTY OFF	OLDIES/FOLK M/DOCUMENT

Stereo/Mono Select

Turn the knob to select [STEREO or MONO], then turn the knob select [STEREO/MONO].

DX/Local Select

Turn the knob to select [LOC or DX], then turn the knob select [DX /LOCAL].

Remark: DX:Distant exchange

Tuner Area Select

Turn the knob to select [REGIONAL], then turn the knob select [ASIA/OIRT/EUR/USA].

RDS ON/OFF

Turn the knob to select [RDS OFF], then turn the knob select [RDS OFF,ON].

DEMO MODE SELECT:

1. Press the knob to enter the [MENU].
2. Turn the knob to select [DEMO MODE], then press the knob.
3. Turn the knob to select [OFF/ON].

Menu	Adjustment
DEMO MODE	OFF/ON

DISPLAY SETTINGS:

1. Press the knob to enter the [MENU].
2. Turn the knob to select [DISPLAY], then press the knob.

Display Settings List

Menu	Adjustment
SPECTRUM	OFF/ON
ID3 TAG	OFF/ON
MODE SEL	C-MODE 1/C-MODE 2/C-MODE 3
BRIGHT	MANUAL M-LEVER 1~8 AUTO A-LEVER 1~8→START→18:00→STOP→07:00
VERSION	VER 1.0

Spectrum ON/OFF

1. Turn the knob to select [SPECTRUM], then press the knob.
2. Turn the knob to select [OFF/ON].

ID3 ON/OFF

1. Turn the knob to select [ID3 TAG], then press the knob.
2. Turn the knob to select [OFF/ON].

Key Light Select

1. Turn the knob to select [MODE SEL], then press the knob.
2. Turn the knob to select [C-MODE 1/C-MODE 2/C-MODE 3].

Key Light Bright Setup

1. Turn the knob to select [BRIGHT], then press the knob.
2. Turn the knob to select [MANUAL], then press the knob.
3. Turn the knob to select [M-LEVER 1~8].
4. Turn the knob to select [AUTO], then press the knob.
5. Turn the knob to select [A-LEVER 1~8], then press the knob.
6. Turn the knob to select [START], then press the knob to setting start time.
7. Turn the knob to select [STOP], then press the knob to setting stop time.

System Version

Turn the knob to select [VERSION], then press the button to query the system version information.

TROUBLE SHOOTING:

Not work

Fuse blown
Loose panel contact

Remedy

Replace the fuse: 10A(Red)
Take out the panel and reinstall

Not responding

System problem

Reset the unit

No bass

Subwoofer setting level
is too small

Enter AUDIO to set SVOL

Can't turn on voice

Bluetooth is not connected
Phone does not support voice

Connect Bluetooth
N.A

Not playing

Incorrect device format
Device error
Unsupported audio file

Reformat
Replacement device
Replace supported audio files

Radio reception is poor

Poor contact of radio antenna
Poor signal at location

Reconnect the radio antenna
Change to other positions

Remote control is invalid

Remote control battery is low

Replace CR2025 battery

Bluetooth call is poor

Microphone is too far away

Speak into the microphone

SPEAKER CONNECTION:

Do not connect the speaker leads of the power cord to the car battery; otherwise, the unit will be seriously damaged.

Before oconnecting the speak leads of the power cord to the speakers, check the speaker wiring in your car.

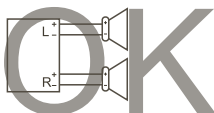
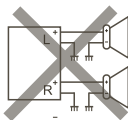
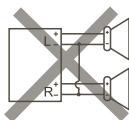

SPECIFICATION:

GENERAL	Power Supply Requirement	DC 12V
	Maximum Power Output	60W X 4CH
	Speaker Impedance	4 - 8 Ohm
	Unit Dimensions(WxHxD)	178 X 111 X 50 mm
	Weight	0.6 kg
	Fuse	10 A

RADIO	FM Frequency Range	65MHz-108.0MHz
	AM Frequency Range	522 KHz~1620 KHz
	Preset	

USB Index	Usable Audio Formats:	MP3/WMA
	USB Port Type:	2.0
	USB Charging:	5V/2A
	Frequency Response:	20 Hz - 20 KHz
	S/N Ratio:	60 dB

BLUETOOTH	Version	Bluetooth 5.1
	BT Profile Supports:	A2DP, AVRCP, HFP
	Range Of Frequency:	2.4 GHz spectrum

APP OPERATION:

APP Download

Method 1: Please scan the QR code on the cover to download the APP and install it on your Android or Apple device.

Method 2: Please go to the APPLE APP Store or Google Play Store and search [AUDIO DSP Control] APP, after downloading the APP, install it on your Appale&Android devices.

APP Connection

- 1.Open the [AUDIO DSP Control] APP, click[🔍] to search for X-510DSP.
- 2.Click X-510DSP to connect, the [🔍] will be red after the connect is successful.

